

**Driver & Company Manual**

# **SE5000-8.1 Smart Tachograph**

---

**STONERIDGE - EVERY ANGLE COVERED**

[www.stoneridgeelectronics.com](http://www.stoneridgeelectronics.com)

[www.se5000.com](http://www.se5000.com)



# Welcome

Thank you for choosing the SE5000-8.1 Stoneridge Smart Tachograph.

At Stoneridge we believe in making your life easier working as a driver or as a fleet owner. Your SE5000-8.1 Tachograph has been designed with this in mind, with functions such as simple menu options, high speed downloads, and remote download capability.

## TachographVersion

Smart Tachograph SE5000-8.1  
Type approval number: e5 0002  
This manual is designed for revision A

## This Manual

Use this manual to familiarize yourself with how to operate the tachograph (Vehicle Unit, VU), in order to obtain the maximum use from it. The manual addresses both drivers and fleet owner companies with vehicles where the tachograph is installed.

The manual consists of three parts:

- **Driver Part** with information for the driver.
- **Company Part** with information for the company owning the vehicle.
- **Reference Part** with additional information used as a reference.

We recommend that all users read the **Driver Part** as a start. This will give you enough information to start using the tachograph. As company owners you also have to read the **Company Part** in order to understand your obligations. You can then use the **Reference Part** to look up specific details while using the tachograph.

## Changes

Stoneridge Electronics reserves the right to introduce changes in design, equipment, and technical features at any time. You cannot, therefore, base any claims on the data, illustrations or descriptions in this Manual.

## Copyright

This manual must not be reprinted, translated, or otherwise reproduced in

whole or in part, without written permission from Stoneridge Electronics AB.

## Operating Safety

### Risk of accident!

Only operate the tachograph while the vehicle is stationary. Operating the tachograph while driving will distract your attention from the traffic and you may cause an accident.

## Internet Information

Further information about Stoneridge SE5000-8.1 Smart Tachograph and about Stoneridge can be found at:

[www.stoneridgeelectronics.com](http://www.stoneridgeelectronics.com)

## Don't open the Case

The tachograph has been installed by authorised personnel.

A tachograph case must never be opened. No tampering with or modifications to the tachograph are permitted. A tamper label

is placed inside the printer housing. The tamper label must not be torn apart.

Here you can see where the tampering label is placed and how it looks when it is untouched.

- The label itself will be red
- On the left-hand side of the label there will be a security ink section
- On the right-hand side Stoneridge Electronics AB and a data matrix code (contains the serial number of the Tachograph) is printed



A tampered label might look like this, and a few examples to check for.

- Void appears as text on the label
- Not correctly attached on the tachograph
- The red label is damaged
- The security ink on the left is broken



### Note!

The tampered label in the image above is missing the security ink on the right side of the label.

### Note!

Unauthorized persons that modify this equipment are committing a punishable offence, depending on the legislation in the country concerned.

## Other Documents

Besides this Driver & Company Manual there are a number of other documents that contain information about the tachograph.

- **Driver Quickguide** - Gives quick information about how to handle the tachograph as driver.

- **Company Quickguide** - Gives you as fleet owner a quick lesson in how to use the tachograph.
- **Workshop Manual** - Contains information for certified smart tachograph workshops. This information is only handed out to workshops qualified by Stoneridge training program.
- **Control Manual** - Contains information for control officers on how to carry out controls on the tachograph and the driver situation.

# Contents

<b>Welcome</b> .....	<b>1</b>
TachographVersion .....	1
This Manual .....	1
Changes .....	1
Copyright .....	1
Operating Safety .....	1
Internet Information .....	1
Don't open the Case .....	1
Other Documents .....	2
<b>Contents</b> .....	<b>4</b>
<b>Driver Part</b> .....	<b>7</b>
The SE5000-8.1 Smart Tachograph .....	8
Card Trays .....	8
Printer Panel .....	8
Buttons .....	9
DSRC .....	9
Display .....	9
Motion Sensor .....	9
Dashboard Integration .....	10
Different Display Views .....	10
Display Views in DDS ON .....	10

Display View in DDS OFF .....	10
Default Display .....	10
Current Speed .....	11
Time Left Driving .....	11
Time Left Resting .....	11
Driver 1 and Driver 2 .....	11
UTC Date and Time .....	11
Local Date and Time .....	12
Ferry/Train .....	12
Working Time .....	12
Driver Timer .....	12
Menus .....	13
How are Activities Registered? .....	13
Manually Registered Activities .....	13
Before you Start Driving .....	14
Insert a Card .....	14
At the End of the Day .....	15
Eject (Withdraw) Driver Card .....	15
Data Stored on the Card .....	15
Two Driver Scenario .....	15
Begin and End Places .....	16
Begin Place .....	16
End Place .....	16

Manually register Begin and End Place .....	16
At Card Insertion .....	17
Manual Entries .....	17
Change a Manual Entry .....	19
Clear all Entries .....	19
Selection of Activity .....	19
Border crossing .....	20
Working Time Directive (WTD) .....	21
DDS in Driver Scenarios .....	21
Start Driving with DDS .....	21
Time Left Driving .....	21
Warning and Pre-warning .....	21
Taking a Break .....	22
Towards the End of the Day .....	22
Weekly Driving Time Limit .....	22
Calendar Time Limit .....	23
Ferry or Train Scenario .....	23
Activate Ferry/Train condition .....	23
End Ferry/Train condition .....	23
Driving Out of Scope .....	24
Load / unload operation .....	24
More on Time Left Driving .....	25

DDS Calculations and Limitations .....	25	Local time function .....	30	Company Inspection .....	40
Driver Timer Display (DTD) .....	25	Drivers Consent to Export Personal Data .....	31	Keep a Record .....	40
Period of Availability (POA) .....	26	Invert Colours on the Display .....	31	Inspection Fails .....	40
In DDS calculations .....	26	View Vehicle Registration Number .....	31	Workshop Inspection .....	40
In WTD calculations .....	27	Bluetooth .....	32	Lock-in/Lock-out Data .....	41
INFO Menu .....	27	Enable the Bluetooth function .....	32	Selling the Vehicle .....	41
How to reach INFO MENU .....	27	Pairing to Bluetooth (ITS) .....	32	When inserting a Company Card. ....	41
Calendar Time Left until Rest .....	27	Connect to an already paired device (ITS) .....	33	Another Company still Locked-in .....	41
Cumulated Driving Time Driver 1/2 .....	27	Remove a paired device (ITS) .....	33	Lock-in Data .....	42
Time to Download and Calibrate .....	28	Remove all paired devices (ITS) .....	34	Lock-out Data .....	42
Product and certification .....	28	Allow RHMI .....	34	Downloading - why? .....	42
Part number and hardware .....	28	Manual entries via RHMI .....	34	Equipment .....	43
GNSS Positioning .....	28	Power Saving Mode (Sleep function) .....	35	Downloading Procedure .....	43
Company Locked in .....	29	Care of Tachograph .....	35	Keep a Record .....	43
DSRC display .....	29	Care of Cards .....	35	Certificate - when not Downloadable .....	43
Driver Settings .....	29	Card damaged, lost or stolen .....	35	Download with Control Card .....	44
Change Language .....	29	Printouts .....	35	Company Card .....	44
DDS Presentation ON/OFF .....	29	Printout Data .....	36	Data Stored at Lock-in/out or Download .....	44
DDS Warnings ON/OFF .....	30	Change the Paper Roll .....	36	Company Card Stored Data .....	44
Change Local Time .....	30	Company Part .....	39		
Daylight Saving Time .....	30				

Tachograph Stored Company		
Activity Data	45	
Company Settings	45	
Show Download Process	45	
WTD Presentation ON/OFF	45	
D8 Data Format	45	
Set Activity when Switching		
Ignition Key on/off	46	
Set Timeout for Manual Entries	46	
Set Vehicle Registration Number (VRN)	46	
Begin and End place	47	
DDS Settings	47	
Table with all DDS Settings	47	
DDS Displays	48	
WTD Settings	50	
<b>Reference Part</b>	<b>51</b>	
Symbols	52	
Symbol Combinations	53	
Available Languages	54	
Available Countries	54	
Built-in Test	56	
Other tests	58	
Display Messages	59	
Printout Examples	73	
Daily Printout (card) (1/2)	74	
Daily Printout (card) (2/2)	75	
Daily Printout (VU) (1/3)	76	
Daily Printout (VU) (2/3)	77	
Daily Printout (VU) (3/3)	78	
Events and Faults (card)	79	
Events and Faults (VU)	80	
Drive Time Info	81	
Technical Data (1/2)	82	
Technical Data (2/2)	83	
Overspeeding	84	
Vehicle Speed	85	
Engine Speed (rpm)	86	
Status D1/D2	87	
Manual Entry Sheet	88	
Data and Specifications	89	
DDS Calculations and Limits	89	
DDS in Details	89	
Certification and Approval	90	
Avoid High Voltage	90	
Data stored in the Tachograph	90	
Insertion and Withdrawal Data	90	
Driver Activity Data	91	
Other Data	91	
Data stored on the Card	91	
Insertion and Withdrawal Data	91	
Driver Activity Data	92	
Electromagnetical Compability	92	
Operating Temperature	92	
ATEX Tachograph	93	
Hazardous Goods Vehicles	93	
The ATEX Tachograph	93	
Visible Differences	93	
Contact Stoneridge	93	
<b>Index</b>	<b>94</b>	



---

# Driver Part

The Driver Part contains the following:

- **SE5000-8.1 Smart Tachograph**- a presentation on what you can see on the SE5000-8.1 Smart Tachograph, the card tray, printer panel, buttons and the different displays. Finally, information on how activities are registered is given.
- **Before you Start Driving** - information about the most frequent handling of the tachograph.
- **At Card Insertion** - Describes how to carry out manual entries.
- **Driver Settings** - this section contains all settings available to the driver.
- **Driver Card** - how to insert and withdraw a card.
- **Printouts** - how to handle the built-in printer.

## The SE5000-8.1 Smart Tachograph

This is a brief presentation of what you can see of the tachograph. The illustration below shows what can be seen when you e.g. enter the vehicle and touch any key on the tachograph. Normally the tachograph is resting and not showing any information in the display window, but a touch of any button will wake it up.

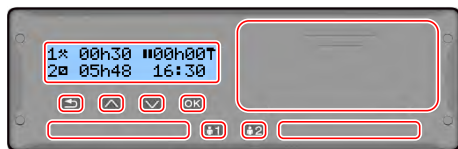

The tachograph is also referred to as the Vehicle Unit (VU). In addition to the tachograph there is a Motion Sensor attached to the vehicle and the Tachograph. Read more about the sensor and integration with the vehicle under **Motion Sensor on the facing page** and **Dashboard Integration on page 10**.

### Card Trays

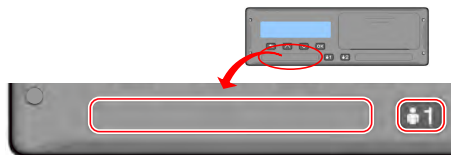

There are two card trays where you insert your driver card.

- **Tray 1** is operated by the button marked **1** and is used for the current driver card.
- **Tray 2** is operated by the button marked **2** and is used for a co-driver card.
- **Open and Close** the trays:
  - **To open** - Press the button and hold it until it opens.
  - **Close** the tray by pushing it in gently.

### Printer Panel

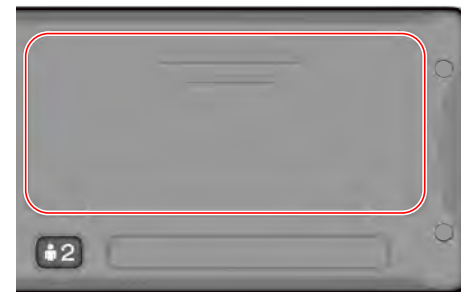

Behind the printer panel there is a printer containing a paper cassette with a paper roll. The printer is used e.g. to make printed records of information stored in the tachograph. The printed paper will come out from a small opening at the bottom of the printer panel.

## Buttons

### Back

- Moves back in a menu
- Returns to the standard display (press repeatedly)

### Arrow up

- Moves up in the menu or a set of views
- Increases a value
- Toggles options

### Arrow down

- Moves down in a menu or a set of views
- Decreases a value
- Toggles options

### OK

- Opens the menu
- Confirms a selection
- Moves horizontally in a menu
- Clears a message or warning

## DSRC

The DSRC, is a unit that is separate from the vehicle unit, and it is used to perform targeted roadside checks via microwave communication link.

It will prove road-side check officers that you are following the legislation and may avoid them stopping you for a formal control.

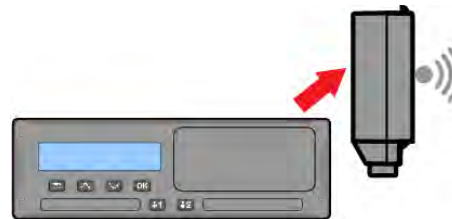

## Display

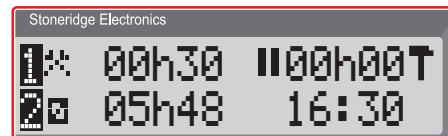

The display is, like any other display unit, used in many different ways:

- Basically the display is used to show information.
- Together with the four buttons (not the numbered buttons) the display is used to navigate in a menu system.
- The display is also used as a feedback when entering information or into the tachograph or changing settings.

## Motion Sensor

The Motion Sensor, or just sensor, is transferring the motion signals from the vehicle to the Tachograph. This is a part of the Tachograph installation and must not be tampered with. Any attempt to tamper with the sensor or the sensor cable is recorded in the Tachograph.



## Dashboard Integration

Some vehicles can display some of the Tachograph information on an integrated display. Here are examples on the type of information that can be displayed:

- Speed
- Travelled distance
- Accumulated Daily Driving Time
- Accumulated Driving Time
- Messages, Warnings and Faults.

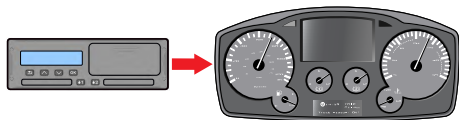

## Different Display Views

The tachograph has two different standard set of Display Views that you easily can browse by using the arrow buttons.

Depending on the two settings below the set of views are different.

- **DDS ON (Driver Decision Support ON).**

- **DDS OFF (Driver Decision Support OFF).**

### Display Views in DDS ON

In the standard set of Views, DDS is shown and the set of Views are:

- Default Display.
- Working Time \*.
- Driver Timer Display (DTD) \*\*\*
- Current Speed.
- Time Left Driving.
- Time Left Resting.
- Ferry/Train \*\*.

\* If enabled, see DDS sections for details.

\*\* If active, see DDS sections for details.

\*\*\* See DTD section for more details.

### Display View in DDS OFF

DDS can be disabled and then the set of Views contains the following:

- Default Display.
- Driver 1.

- Driver 2.
- UTC Date and Time.
- Local Date and Time.
- Driver Timer Display (DTD) \*
- Current Speed.

\* See DTD section for more details.

### Default Display

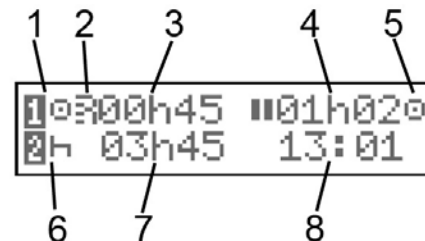

1. Driver's current activity.
2. Indication if there is an open ITS or RHMI connection.
3. Driving time since last break/rest if driving, otherwise duration of current activity.
4. Driver's cumulated break time.

- 5. Operating mode of tachograph.  
Operational mode is automatically entered when no card is inserted or when a driver card is inserted in the tachograph.
- 6. Co-driver's current activity.
- 7. Duration of the co-driver's activity.
- 8. Local time. Replaced by Ferry/OUT when that such mode is activated.

**Current Speed**

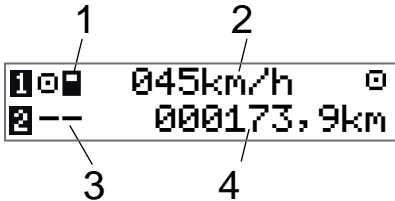

- 1. Type of card inserted in tray 1.
- 2. Current speed.
- 3. Type of card inserted in tray 2.
- 4. Odometer.

**Time Left Driving**

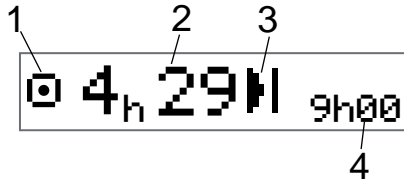

- 1. Time left driving view is shown.
- 2. Time left driving until next activity.
- 3. Next activity (start of daily rest).
- 4. How long the resting time must be to get more driving time.

**Time Left Resting**

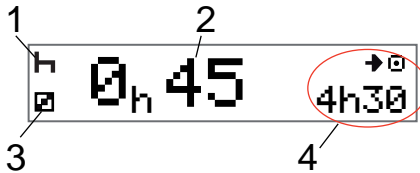

- 1. Driver's current activity (resting).
- 2. Time Left Resting until more driving time is available.
- 3. Co-driver's current activity (available).

- 4. Drive time available after this break/rest.

**Driver 1 and Driver 2**

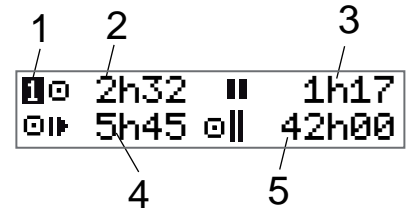

- 1. Indicates if driver or co-driver information is shown.
- 2. Drive time since last break.
- 3. Cumulated break time.
- 4. Daily driving time.
- 5. Cumulated driving time during the current and previous week.

**UTC Date and Time**

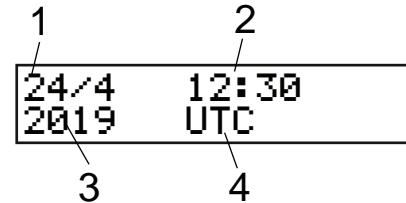

1. Date.
2. UTC time.
3. Year.
4. Indicates that it is UTC time that is used.

*Local Date and Time*

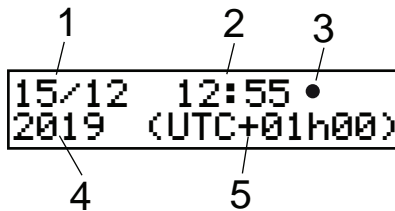

1. Date.
2. Local time.
3. Local time icon.
4. Year.
5. Local time zone offset.

*Ferry/Train*

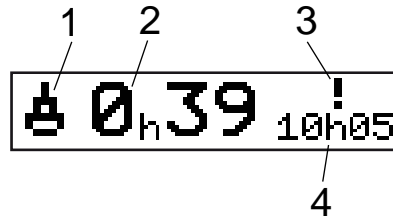

1. Ferry/Train presentation.
2. Remaining interruption time (max 1h).
3. Indication that "Interruption Time" needs to be reduced to fit the Daily rest period in a 24h period.
4. Remaining Daily Rest time.

*Working Time*

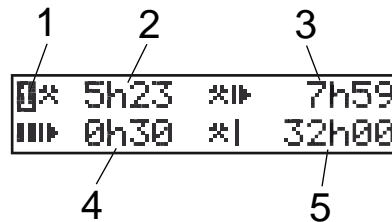

1. Indicate that driver information is shown.
2. Working time since last break.
3. Daily working time.
4. Daily break time.
5. Weekly working time.



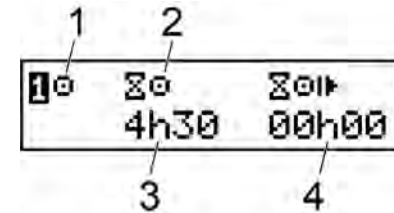

*Driver Timer*



1. Selected activity
2. Type of counter
3. Remaining drive time during Drive or Work / Remaining break time during Rest or Availability
4. Accumulated drive time since calculations started

## Menus

There are four main menus in the display, used for making selections and settings. You navigate in the menus by using the buttons on the tachograph.





	PRINT	Printout selections
	SETTINGS	Available settings
	PLACES	Selection of begin/end places, Out of Scope, Ferry/Train or Load/Unload
	INFO	In the <b>INFO</b> menu you can toggle between five different display views, see <b>INFO Menu</b> on page 27.

## How are Activities Registered?

Activities performed by the driver and the co-driver during the day are registered on the driver card.

Available activities:

	Driving	While driving the vehicle.
--	---------	----------------------------

	Work	While working when the vehicle is standing still, for example when loading the vehicle.
	Available	While not working, for example when you are a co-driver.
	Rest	While taking a break.
	unknown activity	No activity type recorded.

## Manually Registered Activities

The following are the two main situations when you register activities manually:

- When you need to record activities when no driver card was inserted, see above
- If the vehicle is standing still and you would like to change the current activity set by the tachograph. For example, you may change the driver's activity from **Work** to **Rest**. Press shortly on button **1** (to make selections for the driver) or on button **2** (to make selections for the

co-driver) repeatedly until the desired activity is displayed. **Driving** is always selected automatically and cannot be changed.

### Note!

For traffic safety reasons you may only operate the tachograph when the vehicle is standing still.

## Before you Start Driving

The following scenario describes a normal working day with a single driver where:

- **Driver Card was ejected** at the end of the last working day.
- **Driver was resting** until card was inserted.
- **Driver Card is inserted** again when the new working day starts.

### Note!

A driver card must be inserted in the tachograph in order to identify the driver. The driver card is personal and may not be used by anyone else but the rightful card holder.

## Insert a Card

Since this is a single driver scenario card tray 1 is used. If a co-driver is present he/she must insert their card in tray 2.

1. Press and hold button **1** on the tachograph until the tray is opened.
2. Insert the card with the chip facing forward and upwards.

3. Close the tray by pushing it carefully forward.

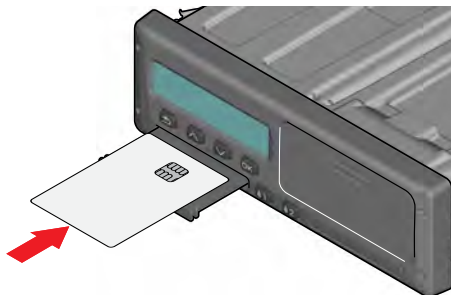

If the inserted card is unknown to the tachograph, drivers consent is requested to export personal data. The display will show:

```
OK to exp  
pers. data?
```

Select **YES** or **NO** and then press **OK**.

The display will, for a moment, show your name, the time for your last withdraw and then it will show:

```
Rest until  
now?
```

4. Press **OK**. The display will show:  

```
End country
```

5. Select the End country for your previous shift and press **OK**. The display will show:

```
Begin country
```

6. Select the start country of your journey and press **OK**. The display will show:

```
Entries  
printouts?
```

7. Select whether to make a printout of the entered data by selecting **YES** or **NO** and then press **OK**. The display will show:

```
Confirm  
entries?
```

8. Select whether to confirm the manual entries done by selecting **YES** or **NO** and then press **OK**. The display will show:

```
Ready to drive  
after veh. Check
```

You are ready to drive. Registration of work activity is mandatory by some countries to confirm that the vehicle check took place.

The card tray will be locked:



- When the vehicle is in motion.
- While the tachograph is busy processing a driver card.
- If the power supply to the tachograph is interrupted.
- If ignition is OFF for ADR tachographs.

**Note!**

If end country was selected when you ejected the card you do not need to register it again. The tachograph does not automatically prompt for begin/end place if card was withdrawn for less than 9 hours.

**Note!**

If the tachograph fails to read the card (driver card authentication), see **Display Messages on page 59**.

**At the End of the Day**

When the driving is done for the day or when driver and co-driver change roles, the card often will be ejected from the tachograph.

**Eject (Withdraw) Driver Card**

1. Press button **1** or **2** on the tachograph. The display will show:

```
End country
Portugal
```

2. Select your end country and press **OK** to confirm. The data is stored on the card and the tray is opened.
3. Press the card up slightly from underneath through the opening on the tray, or push the edge of the tray down until the driver card comes out.
4. Close the tray by pushing it carefully forward.

**Note!**

You cannot eject the card while:

- Driving
- Data on the card is being processed
- (in ADR vehicles) when ignition is OFF

**Data Stored on the Card**

All activities such as working, driving, and resting are registered on the driver card as well as in the tachograph. When driving the card must be inserted in the

tachograph and if you change vehicle you must bring your card with you to the other vehicle. The card fits into all smart tachograph regardless of the brand. Consequently you will always have updated driver data on your card.

The driver card stores data up to the limit of its internal memory. After this limit, new data will overwrite the oldest data.

**Two Driver Scenario**

The present driver's card shall always be inserted in tray **1** and the co-driver's card in tray **2**. When the drivers swap seats they have to swap the cards as well so that the driving time will be registered on the current driver's card.

### Note!

It is strongly recommended that the cards are handled in following sequence:

At withdraw: First withdraw driver's card in slot 1 and wait until card is ejected.

Then withdraw co-driver's card in slot 2.

At insertion: First insert co-driver's card in slot 2 and answer the questions. Then insert driver's card in slot 1 and answer the questions.

It is strongly recommended to NOT swap card at midnight, 23:59 - 00:01, due to card data processing performed by the VU (regulation requirements).

It is strongly recommended to NOT swap card during Ferry or Train Scenario.

## Begin and End Places

When the working day starts and ends, the tachograph needs to know both begin place and end place of the journey.

The tachograph can automatically suggest registering a Begin or End place if the card is left in tachograph during the daily rest. See **Company Settings** on page 45 for further information.

If the function to automatically suggest Begin/End place is activated, you can use it as described below.

### Begin Place

If the card has been inserted for 180 or more minutes and the tachograph has been recording Rest activity for that period, you will be prompted with Begin place when you turn the ignition on. Confirm if you wish to register a Begin Place, and thereafter confirm the Country.

### End Place

If you set the activity to rest and then turn the ignition off, you will be prompted to register the End place. This will also trigger if you change the activity to rest after you turned the ignition off. Confirm if you wish to register an End place and thereafter confirm the Country.

### Note!

Pressing the Back button will cancel the prompt for Begin or End place.

## Manually register Begin and End Place

You can register the places at any time during the day, and during a manual entries procedure. When ejecting the driver card, you will get a question about entering the end place.

To manually register the places during the working day:

1. Press **OK** to show the menu.
2. Select:  
**PLACES**
3. Press **OK** and navigate to:  
**Begin place**
4. Press **OK** and select the place.
5. Press **OK** to confirm.
6. To register destination place, perform the same procedure again but navigate to:  
**End place**
7. Press **OK** to confirm the destination place. Your places are registered.

**Note!**

Any place/country registration will be stored on both cards if there are two valid cards inserted.

**At Card Insertion**

When you have performed activities without the driver card inserted you need to register these activities manually. We assume that you register the activities next time you insert the driver card. Please note that all activities are entered in local time.

**Manual Entries**

The following scenario describes a situation when you need to register manual entries (with your card inserted). Please note that you will most likely not be able to get the same presentation on your display.

- **Friday at 15:23 18/3 2019:** You arrived and ejected the driver card.
- **From 15:23 until 18:00:** You performed other work.

- **From 18:00 over the weekend until 08:00 Monday 21/3:** You rested.
- **From 08:00 to 08:40:** You were available.
- **From 08:40 to 09:37:** You performed other work with unaccounted time. Unaccounted time is time that should not be registered on the driver card, for example driving with an analogue tachograph.
- **Monday at 09:37 21/3 2019:** You insert the driver card.

**Note!**

Manual entries can also be performed using a Bluetooth device. For more information, see **Bluetooth on page 32**.

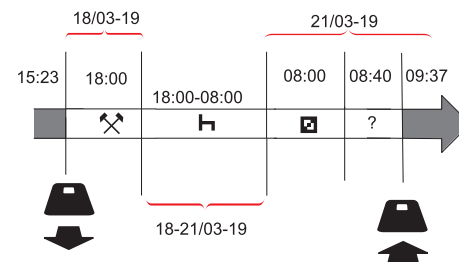

To register manual entries according to the scenario above, do as follows:

1. Insert the driver card. The display will show:  

```
Rest until
now?
```
2. Select **NO** and press **OK**. The display will show:  

```
Add manual
entries?
```
3. Press **OK**. The display will show the date and time for the last card ejection together with the following:  

```
end
shift
```

You will now register the other work you performed 18/3.
4. Highlight the ⌘ symbol.

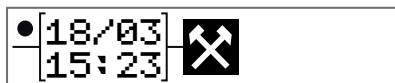

5. Press **OK**.

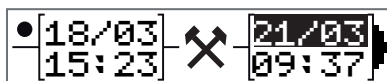

6. The date 18/03 is correct but 21/3 to the right needs to be changed to **18/03**. Change it by scrolling back to **18/03**, using the arrow buttons.

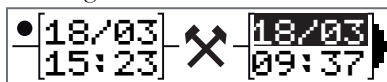

7. Press **OK** to confirm.

8. Change the time (hour) to **18** by scrolling forwards to **18.37** and press **OK**.



9. Change the minutes to **00** by scrolling forwards to **18:00** and press **OK**.



10. Press **OK** again to confirm. The display will show the date and time when the other work was finished together with:  
**end shift**

You will now register the time when you rested.

11. Highlight the rest symbol **H** and press **OK**.



12. Press **OK** to confirm the date (**21/03**, which already is correct.

13. Change the hour by scrolling to **08** and press **OK**.

14. Change the minutes by scrolling to **08:00** and press **OK**.

15. Since the rest was longer than nine hours, the following is displayed.

**Begin country**

16. Select start country and press **OK**.

17. Press **OK** again to confirm. The date and time when the rest was finished is displayed together with the following:

**begin shift**

You will now register the time when you were available.

18. Highlight the available symbol **□** and press **OK**.



19. Press **OK** to confirm the date (**21/03**), which already is correct.

20. Change the hour by scrolling to **08** and press **OK**

21. Change the minutes by scrolling to **08:40** and press **OK**.

22. Press **OK** again to confirm. The date and time when the available period was finished is now displayed together with the following:

**begin shift**

You will now register your work with unaccounted time. This will *not* be registered on the driver card.

23. Highlight the **?** symbol and press **OK**.

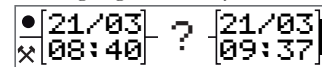

- 24. The time between the last activity (unaccounted time) and the time when the card was inserted is displayed, which is correct). Press **OK** to confirm
- 25. Press **OK** again to confirm.

You have now registered all work, rest, available time, and unaccounted time for the period when no card was inserted. The following will be displayed:

Entries  
printout?

- 26. Select whether or not to make a printout of the entered data by selecting **YES** or **NO**. We assume that you will not make a printout (for information about printouts, see section **Printouts on page 35**).
- 27. Press **OK**.The following is displayed:

Confirm  
entries?

- 28. Press **OK** to confirm and save the entries. Now the display will show the following:

Ready to drive  
after veh. Check

### Change a Manual Entry

You can go back and change your manual entries by using the **Back** button at any time.

You can make changes at the latest before you answer **YES** on the question:

Confirm  
entries?

- 1. Select **NO** and press **OK**.
  - 2. Select the following:
- Change  
entry?
- 3. Press **OK** and the first manual entry is displayed again.
  - 4. Navigate to the entry that you will change. Carry out the changes according to the procedure above.

### Clear all Entries

To start over again, do as follows when the following is displayed:

Confirm  
entries?

- 5. Select **NO** and select:

Clear all  
entries

- 6. Press **OK** and register new entries according to the procedure above.

#### Note!

The manual mode will be closed when driving begins or when no interaction has been made with the tachograph for 1 or 20 minutes, depending on the settings.

### Selection of Activity

When the vehicle is stopped, the following activity types can be manually selected for the driver and co-driver.

 **Work**

 **Rest**

 **Available**



1. With the Card still in the tachograph press the (1/2) button shortly. If you are the driver you must use the (1) button and if you are a co-driver you must use the (2) button.
2. Press again shortly until you have the right symbol displayed.
3. Wait for the tachograph to switch back to the selected view (that you previously have selected).

### **Border crossing**

The tachograph contains a map that, with an active GNSS, will automatically detect and register any border crossing. If the tachograph detects that you crossed a border and stayed within that new country for more than 120 seconds, it will automatically register a border crossing record in the tachograph and on the card.

Manual entry of Border crossing is not required, contrarily to older generation tachographs.

### **Note!**

If the inserted card is Gen1 or Gen2 v1 the tachograph will instead store a Start country record on the card.

## Working Time Directive (WTD)

This version of the Stoneridge Smart Tachograph supports the EU Working Time Directive (2002/15/EC).

## DDS in Driver Scenarios

DDS includes both the Working Time Directive and the Ferry/Train Mode in the calculations.

DDS is described in a driving scenario that has the following components:

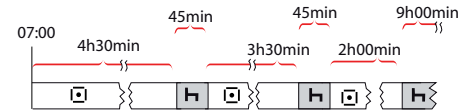

The main part of this scenario will be described below together with the Time Left Driving View.

## Start Driving with DDS

Assume that you start driving in the morning at e.g. at 7 in the morning. In the illustration below you insert the card and start driving at the same time (A).

According to the current regulations you are allowed to drive for 4 hours and 30 minutes before you have to make a 45 minutes break (or 15 + 30 minutes). The end of the accumulated driving time is marked with the symbol at position (B).

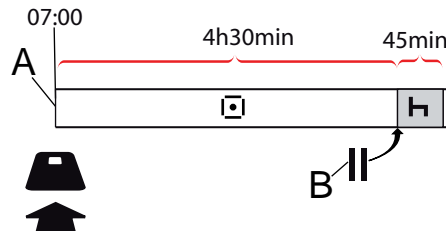

## Time Left Driving

DDS keeps track of your driving time and shows the Time Left Driving.

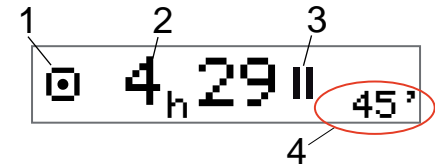

1. Icon is indicating that this is the Time Left Driving View.
2. You can drive for 4 hours and 29 minutes before you must take a break.
3. Next required activity will be a break.
4. Next required break must be at least 45 minutes.

## Warning and Pre-warning

When there is 15 minutes remaining to drive the tachograph will give a Pre-warning. A Warning will be shown when you must stop driving.

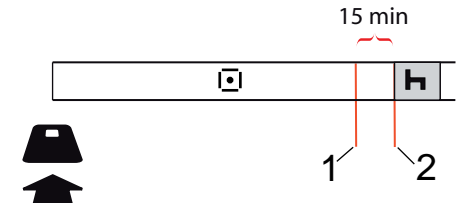

1. Pre-warning - will be shown 15 minutes before Time Left Driving has elapsed.
2. Warning - will be shown when Time Left Driving has elapsed.

### Taking a Break

Similar to the Time Left Driving View the DDS will present a Time Left Resting View when you are resting.

45min

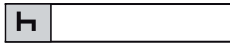

This is the first break after 4.5 hours driving.

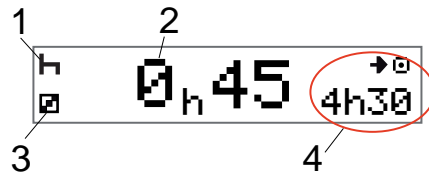

1. Driver is resting.
2. Remaining resting time is 45 minutes.
3. Availability is the activity selected for the co-driver.

4. You can drive 4 hours and 30 minutes when you have finished your rest.

### Towards the End of the Day

At the end of the day, the next activity has changed to Daily Rest instead.



After a day with: 4.5 hour driving, 45 minutes break, 3.5 hours driving, 45 minutes break and finally driving for 1 hour and 28 minutes, the following is shown.

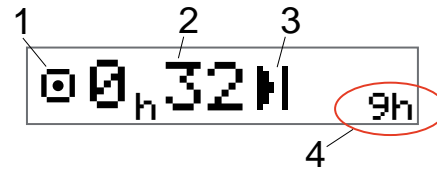

1. Icon is indicating that this is the Time Left Driving View.
2. You can drive for 32 minutes before you must take a rest.

3. Icon showing the next required activity will be the Daily Rest.
4. Showing that you will have to take a 9 hour rest.

### Weekly Driving Time Limit

When the weekly drive time limit is near, the view will look like this:

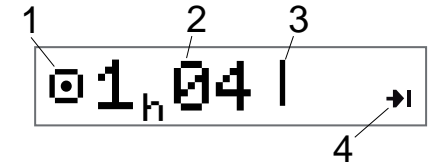

1. Icon is indicating that this is the Time Left Driving View.
2. Time left to drive this week.
3. Icon showing that you must fulfil your Weekly Rest.
4. Icon indicating that you must wait for the next week to get more driving time. You must wait for the next UTC week.



## Calendar Time Limit

The drive time left view will show this when the next activity required will be a weekly rest:

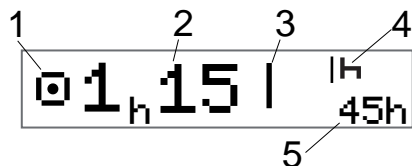

1. Icon is indicating that this is the Time Left Driving View.
2. Time left to drive this week.
3. Icon showing that you must fulfil your Weekly Rest in order to get more driving time.
4. Icon showing the Weekly Rest has to be started immediately after the Driving Time has elapsed.
5. Showing the duration of the rest (45 hours).

## Ferry or Train Scenario

When taking your regular daily rest, or reduced/regular weekly rest, in

conjunction with travelling by ferry or train there is a possibility to interrupt the rest twice to embark and disembark the ferry or train. For DDS to calculate the rest correctly enter Ferry/Train special condition when starting the rest on the ferry/train according to the picture below.

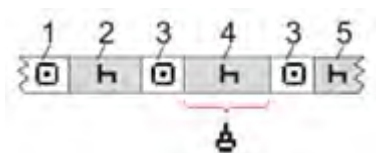

1. Driving to ferry/train
  2. Rest during waiting time at the ferry/train terminal.
  3. Driving during embarkation/disembarkation of the ferry/train (interruption 1).
  4. Rest during ferry/train journey.
  5. Continued rest after ferry/train journey.
- Period 2, 4 and 5 will be counted as one continuous rest, provided both periods (3) are periods of drive/work without interruptions, and that they do not exceed 60 minutes in total.

## Activate Ferry/Train condition

To activate the ferry/train condition (when starting the rest on the ferry/train):

1. Press **OK** to show the menu.
2. Select:  
PLACES
3. Press **OK** and select:  
Ferry/train
4. Press **OK** to confirm. The Ferry/train activity is activated.

## End Ferry/Train condition

For latest issued driver card, in a Smart Tachograph, it is possible to end an ongoing Ferry/Train condition. E.g. if your daily rest is fulfilled during the journey (4) and you do not want to continue with more rest (5), it is possible to end the ferry/train condition before disembark.

1. Press **OK** to show the menu.
2. Select:  
PLACES
3. Press **OK** and select:

### End Ferry/train?

4. Press **OK** to confirm. The Ferry/train activity is deactivated.

#### Note!

An active Ferry/train condition will automatically end when the driver card is withdrawn, or when the tachograph has registered one minute of driving.

If you eject the card during ferry/train journey (4), the display will, at next card insertion, show a ferry symbol with a question mark. Indicating that an ongoing ferry/train is possible to continue. Activate the Ferry/Train condition again if desired.

The Ferry train view (see **Ferry/Train on page 12**) will automatically appear if conditions are correct for a "daily rest interrupted by ferry/train".

It is only possible to get DDS support for Ferry/Train once during a day/daily rest. It is recommended that ignition shall be turned off at short Ferry/Train journey to avoid motion errors.

#### Note!

We recommend not to remove the card from the tachograph during the daily rest while utilizing the ferry/train condition. We also recommend avoiding changing drivers during an ongoing daily rest that includes ferry/train condition.

For more information also see **Data and Specifications on page 89**.

### Driving Out of Scope

Some driving conditions do not require recording of time on the tachograph, for example driving in countries where no such legislation exists. This driving mode is called out of scope.

For detailed information, see national regulations and EU tachograph regulations 561/2006.

#### To activate or deactivate the out of scope mode:

1. Press **OK** to show the menu.
2. Select:

PLACES

3. Press **OK** and select:

Out of scope

4. Press **OK**.

- If you turned the out of scope mode on, the Default Display View will show:

OUT

The out of scope mode is activated.

- If you are turning off the out of scope mode, the display will show:

End out  
of scope?

5. Press **OK** to confirm. The out of scope mode is deactivated.

### Load / unload operation









As a driver you can manually register when performing a load/unload or simultaneous load & unload operation. Only one operation of each type can be performed within a calendar minute.

#### To confirm an operation, follow the steps below:

1. Press **OK** to show the menu.
2. Select:

PLACES

3. Press **OK** and select:  
**Load/Unload**
4. Press **OK**.
5. Press the button below the desired operation pictogram according to the table below:



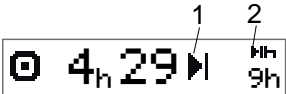

Display	Button	Function
		Abort and go back to previous menu
		Confirm a Load operation
		Confirm an Unload operation
		Confirm a simultaneous Load & Unload operation

### More on Time Left Driving

The Time Left Driving View can hold different information during a driving scenario.



The following pictogram can be shown in position (1) and have the following meaning:

-  Time for break 45 or 15 + 30 min
-  Time for daily rest 11 or 9 hours
-  Time for weekly rest or weekly drive time limit reached. 45 or 24 hours or wait until next week
-  2-weeks drive time limit reached Wait until next week

If a pictogram (2) is shown, it has the following meaning:

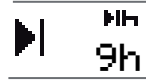

A daily rest must start immediately when the remaining time is zero.



A weekly rest must start immediately when the remaining time is zero.



Working time is the cause of next break or rest.

### DDS Calculations and Limitations

The Reference Part contains a more detailed description of the DDS calculations and limitations. See **Data and Specifications on page 89**.

### Driver Timer Display (DTD)

The Driver Timer Display (DTD) in the tachograph is used for assistance of the drive and rest times when the driver is outside of the regular DDS calculation.

The DTD works without a driver card inserted. It is also not affected by ejecting the driver card as the timers are based on activities registered in the tachograph and not on the driver card inserted.

**To activate the DTD function:**

1. Navigate to the DTD display.
2. Press and hold **OK** to activate.
3. Timers are now ready to record drive and rest.

**To deactivate the DTD function:**

1. Navigate to the DTD display.
2. Press and hold **OK** to deactivate.
3. The function is now deactivated and reset.

**Note!**

DDS related warnings will be deactivated while you are on this display and DTD is active, except the 4h30 warning.

Function deactivated and timers reset.

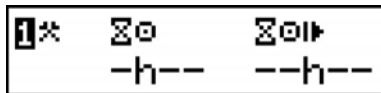

Function is active and current activity is work. Work activity will not affect the timers.

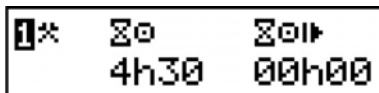

Function is active and current activity is Driving. The timer on the left will count down until 0h00 with each drive minute registered in the tachograph after activating the function. It will be reset after 45 min of Rest/Availability. The timer on the right will count up until it reaches 99h59, or the function is deactivated.

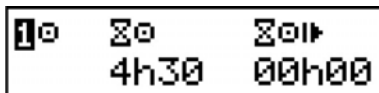

Function is active and current activity is Rest. Rest and Availability will count down the timer on the left from 45 minutes until 0h00. It will not affect the timer on the right. 15 min + 30 min can also be used instead of 45 min.

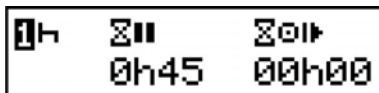

Function is active and current activity is Availability. Rest and Availability will count down the timer on the left from 45 minutes until 0h00. It will not affect the timer on the right. 15 min + 30 min can also be used instead of 45 min.

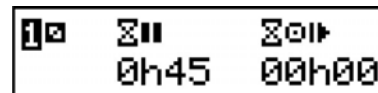

**Period of Availability (POA)**

**In DDS calculations**

In the Driver Decision Support mode the POA can be calculated as break (YES) or not calculated as break (NO).

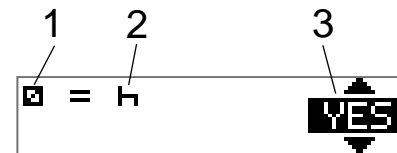

1. Pictogram for availability.
2. Pictogram for break.

- The command can be toggled between YES (POA calculated as break) and NO (POA *not* calculated as break).

### In WTD calculations

Due to different regulations in European Union the period of availability can be calculated either as a *break* or as *work*.

In the Working Time Directive mode the POA can be calculated as work (YES) or not calculated as work (NO).

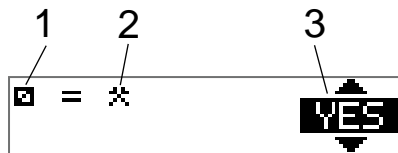

- Pictogram for availability.
- Pictogram for work.
- The command can be toggled between YES (POA calculated as work) and NO (POA *not* calculated as work).

### INFO Menu

When you select the Info menu the following Views are presented:

- Calendar Time Left to Rest.
- Accumulated Driving Time Driver 1.
- Accumulated Driving Time Driver 2.
- Local Date and Time.
- UTC Date and Time.
- GNSS data.
- Product, Software Identification Number and certificates.
- Article number, variant, and hardware number.
- Company Locked in.
- Time to Download and Calibration.
- DSRC serial and certificate number.

#### Note!

The Info menu is only available when the vehicle is stationary.

### How to reach INFO MENU

You can reach the INFO Menu in the following way:

- Press **OK** to show the menus.
- Select:  
**INFO**

- Press **OK**.

Now, you can use the arrow buttons to move between the different views.

### Calendar Time Left until Rest

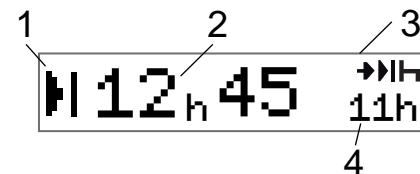

- Calendar Time until Rest icon.
- Calendar time left until a rest must start.
- Icon indicating that next rest must be a daily rest.
- Indicates how long the resting time must be (11 hours in this case).

### Cumulated Driving Time Driver 1/2

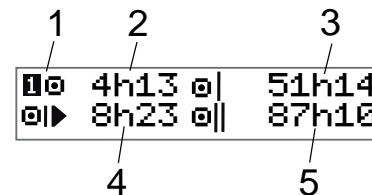

1. Driver 1 (there is a similar display for driver 2).
2. Continuous Driving Time.
3. Cumulated Weekly Driving Time.
4. Cumulated Daily Driving Time.
5. Cumulated 2-Week Driving Time.

*Time to Download and Calibrate*

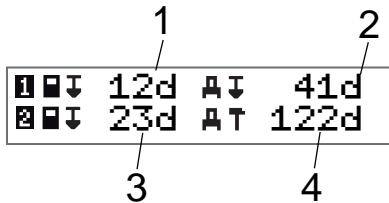

1. Days left until the Driver 1 Card has to be downloaded.
2. Days left until tachograph data has to be downloaded.
3. Days left until the Driver 2 Card has to be downloaded.
4. Days left until the tachograph has to be calibrated.

*Product and certification*

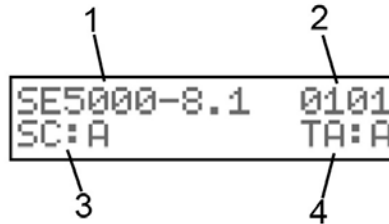

1. Product name
2. Software identification number (SWID)
3. Security certification
4. Type Approval certificate

*Part number and hardware*

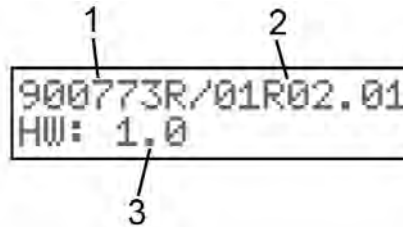

1. Part number
2. Variant number and version
3. Hardware number

*GNSS Positioning*

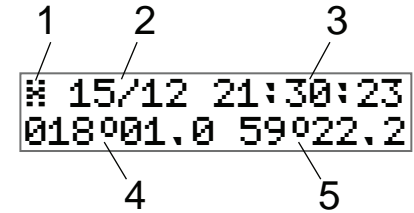

1. GNSS pictogram and Authentication status.
2. Date (dd/MM) of latest position from GNSS.
3. Time (hh:mm:ss) of latest position from GNSS (UTC time). If time is static, there is currently no GNSS reception.
4. Latitude.
5. Longitude.

*Company Locked in*

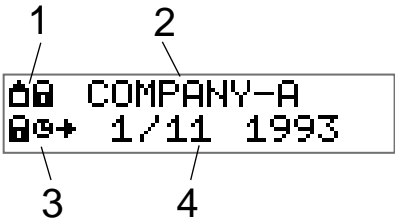

1. Company Locks pictogram combination.
2. Name of company with an active lock.
3. Pictogram indication lock in starting time.
4. Date when company data was locked in.

*DSRC display*

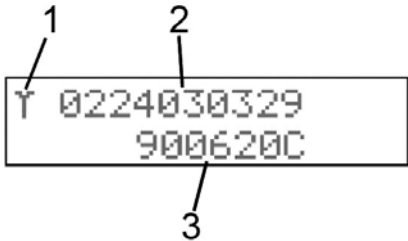

1. DSRC pictogram
2. DSRC extended serial number
3. DSRC certification number

**Driver Settings**

The driver can make the following settings:

- Change Language
- Enable/Disable DDS Presentation
- Enable/Disable DDS Warnings
- Change Local Time
- Daylight Saving Time
- Change Local time function
- Invert Colours on the Display
- Drivers consent to export personal data
- View Vehicle Registration Number (VRN)
- Enable/Disable WTD Presentation
- Bluetooth pairing/connection/RHMI

**Change Language**

By default, it is the driver card language that is used in the tachograph and on

printouts, but you can change which language is to be used.

If you change language, the new language will be saved only in the tachograph, not on the driver card.

1. Press **OK** to show the menu.
2. Select:  
**SETTINGS**
3. Press **OK** and select:  
**Language**
4. Press **OK** and select the desired language.
5. Press **OK** to confirm. The language is changed.

**DDS Presentation ON/OFF**

By default the DDS (Driver Decision Support) is enabled (ON), but it can be switched OFF which means that not only the presentation is switched off but also all warnings associated with the DDS.

1. Press **OK** to show the menu.
2. Select:  
**SETTINGS**
3. Press **OK** and select:

### DDS Settings

4. Press **OK** and select:  
DDS enable
5. Select **OFF** to disable the DDS presentation.
6. Press **OK** to confirm. The DDS presentation is now disabled.

### DDS Warnings ON/OFF

By default the DDS warnings (Driver Decision Support) are enabled (ON), but they can be switched OFF.

1. Press **OK** to show the menu.
2. Select:  
SETTINGS
3. Press **OK** and select:  
DDS Settings
4. Press **OK** and select:  
DDS warnings
5. Select **OFF** to disable the DDS warnings.
6. Press **OK** to confirm. The DDS warnings are now disabled.

### Change Local Time

#### Note!

This menu option is not available if Local time function is set to ALTA (Automatic Local Time Adjustment).

Local time is the current time in a specific country. Local time is only shown as information on the display and on some printouts.

The local time can also be set manually and can be adjusted in steps of 30 minutes.

1. Press **OK** to show the menu.
2. Select:  
SETTINGS
3. Press **OK** and select:  
Local time
4. Press **OK**.
5. Change the time, using the arrow buttons.
6. Press **OK** to confirm. The local time is changed.

### Daylight Saving Time

In EU countries, the last Sunday in March and October the tachograph will remind you to change the local time according to Daylight Saving Time (local summer/winter time).

1. When adjustment is needed, the display will show:  
New time?
2. Press **OK** to confirm. The local time is changed.

### Local time function

The function allows the driver to select whether the tachograph uses automatic functions for the local time.

1. Press **OK** to show the menu.
2. Select:  
SETTINGS
3. Press **OK** and select:  
Local time func
4. Press **OK**.



5. Change the setting, using the arrow buttons.
6. Press **OK** to confirm. The local time function is changed.

This setting has 3 options for the driver to select:

**OFF** – The tachograph allows any user to change the local time using the Local time menu or by sending a local time change using other interfaces, e.g. CAN or Diagnostic.

**DST** – Still allows the same functionality as OFF, however will also prompt the driver to confirm local time when Daylight Saving Time (DST) changes.

**ALTA** – This option will allow the tachograph to perform an automatic local time adjustment (ALTA) based on the time zone of the current country. Local time will also be automatically changed based on the DST. The changes to local time require no user input.

### Note!

When the ALTA option is selected, the local time menu will not be available. The function to change local time via another interface will only be available when the tachograph is in calibration mode.

### Drivers Consent to Export Personal Data

The driver can choose to accept export of personal data from the tachograph.

1. Press **OK** to show the menu.
2. Select:  
`SETTINGS`
3. Press **OK** and select:  
`Drivers Consent`
4. At:  
`OK to exp  
pers. data?`

Select **YES** or **NO**.

5. Press **OK** to confirm. The setting is now saved.

### Invert Colours on the Display

There are two modes for the display: dark background with light text or light background with dark text.

1. Press **OK** to show the menu.
2. Select:  
`SETTINGS`
3. Press **OK** and select:  
`Invert display`
4. Press **OK** to confirm. The display is inverted.

To reset the display, follow the same procedure but select **NO** in step 3.

### View Vehicle Registration Number

The Vehicle Registration Number (VRN) can be viewed by the driver but it needs a company card to set it, see **Set Vehicle Registration Number (VRN) on page 46**.

1. Press **OK** to show the menu.
2. Select:  
`SETTINGS`
3. Press **OK** and select:

### Reg. Number

4. Press **OK** to confirm. The vehicle registration number is displayed.

## Bluetooth

This tachograph comes equipped with Bluetooth functionally you to connect your phone/tablet or equivalent device to it. It allows for 1 device to be connected while there is a valid card inserted, and for up to 16 devices to be paired. The tachograph will remember what device was used with each card for a quicker connection when next used together.

The Bluetooth function is divided into two parts, the ITS and the RHMI.

The ITS part allows for Download and Calibration/Diagnostic as per Appendix 7 and Appendix 8 of Annex 1C.

The RHMI part allows for Manual entries as defined in the [Smart tachograph version 2 VU, Remote HMI specification & Transport protocol for ITS](#)

The Driver consent for each card which the driver needs to input regulates what data can be used over the ITS and RHMI.

This Driver consent can later be changed via the menus in the tachograph.

To use the RHMI functions each driver card inserted in the tachograph also needs to confirm if it allows RHMI or not. This allowance can later be changed via the menus in the tachograph.

In the main display you can see if there is an active ITS or RHMI connection next to the activity pictogram for driver 1.

### ITS

```
10300h45 1101h000  
00 03h25 09:50
```

### RHMI

```
10300h45 1101h000  
00 03h25 09:50
```

## Enable the Bluetooth function

You can enable/disable the Bluetooth function in the tachograph by following below steps:

1. Press **OK** to show the menu.
2. Select:  
**SETTINGS**
3. Press **OK** and select:  
**Bluetooth**
4. Press **OK** and select:  
**Enable Bluetooth**
5. Press **OK**, select **YES** or **NO**, and confirm with **OK**.

## Pairing to Bluetooth (ITS)

To pair your device to the tachograph, follow below steps:

1. Insert your card in the tachograph.
2. Press **OK** to show the menu.
3. Select:  
**SETTINGS**
4. Press **OK** and select:  
**Bluetooth**
5. Press **OK** and select:  
**Pair new Device?**

6. Press **OK** to allow for a device to be paired (will timeout after 300sec). You can abort the pairing process by pressing **Back**.
7. On your device activate Bluetooth pairing to the tachograph. SE5000-xxx (where xxx is the serial number of the tachograph)
8. When pairing token is displayed select **YES** to confirm the pairing to your device.

```

✓ 3 Pairing
Complete

```

After a successful pairing and connection, the main display will show a pictogram informing that a Bluetooth/ITS device is now connected.

```

0h309h05 009h050
0h 09h05 06:50

```

### Connect to an already paired device (ITS)

The tachograph will store your connected device and card data so it can automatically connect again next time you insert your card. If you are new to this

tachograph and wish to connect to an already paired device, follow below steps:

1. Insert your card in the tachograph.
2. Press **OK** to show the menu.
3. Select:  
**SETTINGS**
4. Press **OK** and select:  
**Bluetooth**
5. Press **OK** and select:  
**Paired devices**
6. Press **OK** and select the device you wish to pair to:  
(The bottom row will display the device name)  
**Paired devices**  
-----
7. Press **OK** and select:  
**Connect to**  
-----
8. The tachograph now allows the device to open the connection.

After a successful connection the main display will show a pictogram informing that a Bluetooth/ITS device is now connected.

```

0h309h05 009h050
0h 09h05 06:50

```

### Remove a paired device (ITS)

The tachograph will store the last 16 paired devices:

1. Press **OK** to show the menu.
2. Select:  
**SETTINGS**
3. Press **OK** and select:  
**Bluetooth**
4. Press **OK** and select:  
**Paired devices**
5. Press **OK** and select the device you wish to pair to:  
(The bottom row will display the device name)  
**Paired devices**  
-----
6. Press **OK** and select:  
**Remove?**  
-----
7. The tachograph will remove the paired device and return to:

## Paired devices

### Remove all paired devices (ITS)

The tachograph will store the last 16 paired devices:

1. Press **OK** to show the menu.
2. Select:  
`SETTINGS`
3. Press **OK** and select:  
`Bluetooth`
4. Press **OK** and select:  
`Paired devices`
5. Press **OK** and select the device you wish to pair to:  
(The bottom row will display the device name)  
`Remove all devices`
6. Press **OK** and confirm **YES** with **OK** if you wish to remove all devices.

### Allow RHMI

Each driver of the currently inserted cards needs to confirm that they allow Remote HMI (RHMI).

When a RHMI session is started the Allow RHMI question will automatically appear if a card has not confirmed it before. If none of the inserted cards have accepted RHMI, the question will be asked twice, once per card. The Allow RHMI question can also manually be accessed by following below steps:

1. Press **OK** to show the menu.
2. Select:  
`SETTINGS`
3. Press **OK** and select:  
`Bluetooth`
4. Press **OK** and select:  
`RHMI`
5. Press **OK** and select:  
`Allow RHMI?`

6. Press **OK**.
7. If two cards are inserted, select the card you want and press **OK**.
8. When Slot number with Allow RHMI question is displayed select **YES** or **NO**, and confirm with **OK**.

### Manual entries via RHMI

You can enter your manual entries using a RHMI connected device.

This can only be performed if you have previously paired the device to the tachograph with your card inserted and all inserted card accepted that RHMI can be used.

1. Insert your card.
2. When `Rest until now?` is displayed, you can start Manual entries via RHMI.
3. Information will now be displayed during the manual entries.  
`!R RHMI Manual Entries ongoing...`
4. When manual entries are completed below will be displayed.

```
Ready to drive
after veh. Check
```

If you abort the process during ongoing manual entries below will be displayed.

```
!⊗ RHMI Manual
Entries aborted
```

If you start driving during ongoing manual entries, the process will be aborted, and nothing will be saved.

## Power Saving Mode (Sleep function)

When the ignition key is switched off the tachograph will turn to power saving mode ten minutes after the last interaction. In power saving mode the display is off.

The display will be switched on again when:

- Pressing any button once
- Switching the ignition key on
- Taking the vehicle in tow

## Care of Tachograph

To obtain a long and trouble-free lifetime for the tachograph please keep the following in mind:

- Keep the trays closed at all times and only open them to insert and withdraw a card.
- Do not place objects on the trays when they are open, otherwise they could be damaged.
- Keep the tachograph clean.
- Clean a dirty tachograph with a damp, soft cloth.

## Care of Cards

Treat your card with care and please note the following:

- Do not flex or bend the card.
- Ensure that the card contacts are kept free from dirt and dust.
- Clean it with a soft damp cloth if necessary.
- Protect it from damage.

- If a card is rejected as invalid, clean the chip and reinsert.

## Card damaged, lost or stolen

If the card is damaged, lost or stolen the owner has to request a replacement card from the responsible authority in the country where the card was issued.

If a card is stolen or if the owner suspects that an unauthorized person has access to the card, the owner has to report the incident to the local police and obtain a police report number.

A driver without a valid driver card is not permitted to drive a vehicle equipped with a smart tachograph.

## Printouts

You can view the information stored in the tachograph and on the driver cards by printing it on paper or by showing it on the display. There are a number of different presentations available, which you can read more about in **Printout Examples on page 73**

## Printout Data

1. Press **OK** to show the menu and select:  
`PRINT`
2. Press **OK** and select the type of printout to make. Then press **OK**.

Some types of printouts require specification of the driver card and a date. If so the following is displayed:

`Select card 1 or 2`

3. Select **1** to make a printout for the current driver's card or **2** to make a printout for a co-driver's card.

Some printouts require selection of the file system generation (generation 2 cards has two file systems, gen 1 and gen 2). If so the following is displayed:

`Card gen 1 or 2`

4. If applicable, select card file system generation 1 or 2
5. Select the desired date by using the arrow buttons and press **OK**.
6. Now you select whether to view the data on the display only or to make a printout on paper.

- To view the data on the display only, select:

`display`

- Press **OK** and scroll through the data using the arrow buttons and then press **OK** to return.

- To make a printout on paper, select

`printer`

- Press **OK**. The display will show:

`Printer busy`

- If you would like to cancel the process, press and hold the **Back** button. Wait until the message is cleared and then pull the printout upwards to tear it off.

### Note!

To avoid paper jam make sure the slot on the paper cassette is not blocked.

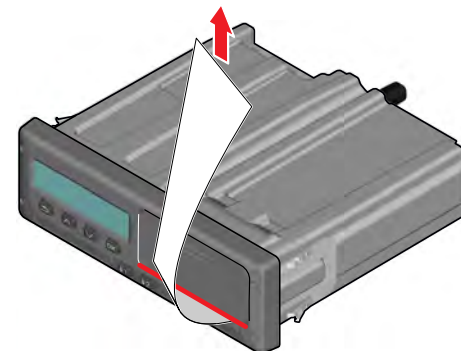

## Change the Paper Roll

### Note!

To avoid malfunctioning only use printer paper approved by Stoneridge.

1. Press the upper edge of the front panel. The panel opens.

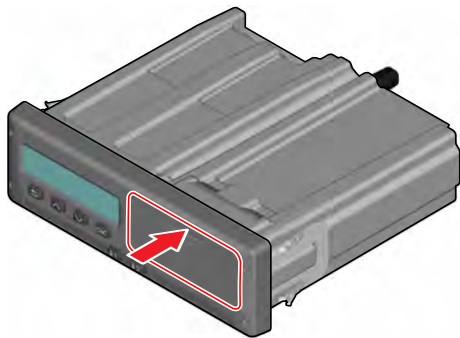

2. Hold the lower edge of the panel and carefully pull out the cassette.

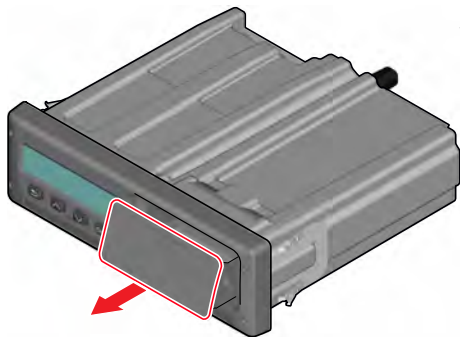

3. Feed the paper around the back of the paper cassette and forwards, passing the lower edge of the panel.

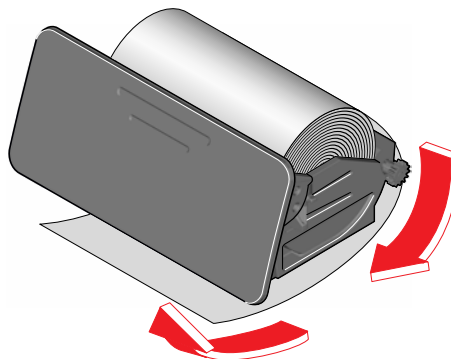

4. Insert the paper into the printer.
5. Slide the paper cassette into the tachograph and press the lower part of the panel to close.

6. Pull the paper upwards and tear it off.

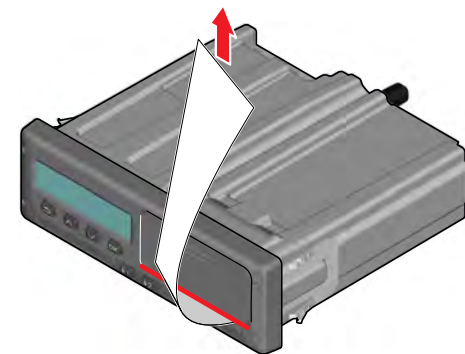
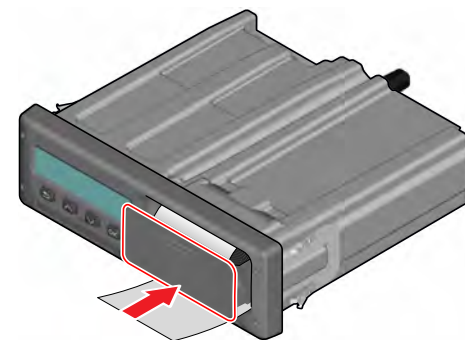





## Company Part

The Company Part contains information especially for the vehicle owners and hauliers who have certain responsibilities that are described in the following main sections:

- **Company Inspection** - the company is obligated to carry out inspections of the Tachograph and keep records.
- **Workshop Inspection** - the company has to administrate a workshop inspection of the Tachograph and store records from the inspection.
- **Lock-in and Lock-out Data** - the company can lock in data in order to make the data out of reach for unauthorised persons. This together with a reset function (lock-out data) is described here.
- **Download Data** - the company is obligated to carry out download of tachograph data.
- **Company Card** - contains information about the company card.

- **Company Settings** - a few settings are only available for the company staff and these settings are found here.

### Note!

The company must make sure that all their vehicles are equipped with a smart tachograph if required by EU regulations and national laws. The company card is personal and may not be used by anyone else but the rightful card holder.

## Company Inspection

The company inspection shall ensure that:

- The Type Approval Number is correct.
- The UTC time is accurate by less than 5 minutes.
- The tachograph is within the correct calibration interval.
- The installation plaque is valid and not broken.

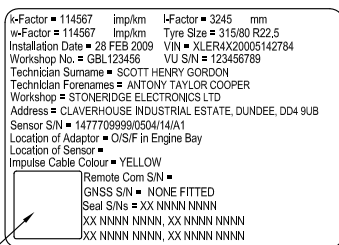

HOLO GUARD LABEL

- The tamper label is not torn apart.

The company inspection should also ensure that:

- The stored calibration factors as seen on the technical data printout agree with what is recorded on the installation plaque.
- The tachograph's internally stored vehicle parameters (Vehicle Identification Number [VIN] and Vehicle Registration Number [VRN]) agree with the actual vehicle data.
- The tachograph does not have any visible damage.
- The tachograph does not have events or faults that impacts the produced data. Events and faults data can be used to verify this.

### Keep a Record

Keep a record of the Company Inspection.

### Inspection Fails

If there are faults in any of the items included in a company inspection, or if there is any doubt regarding the company

inspection, the vehicle must be taken to a smart tachograph workshop for inspection.

If not it can result in a decision that the company is breaking EU, EEA and AETR tachograph regulations and the vehicle, in which the tachograph is fitted, will be invalid for use.

### Note!

Consult relevant authority for national regulations.

## Workshop Inspection

The tachograph installation has to undergo a workshop inspection every second year. It is the company's responsibility to administrate this inspection and to take care of records from the inspection (carried out at a workshop authorized for Smart Tachographs).

The installation plaque, fixed near the tachograph, states the date for last inspection. You can also find the next calibration date printed at the bottom of the technical printout.

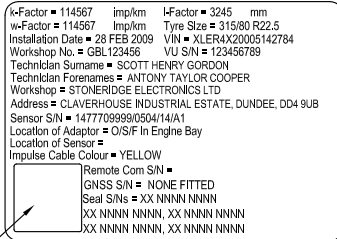

HOLO GUARD LABEL

**Note!**

The installation plaque must always be valid and not broken.

Ensure that the information in the tachograph test certificate received after a workshop periodic inspection is accurate.

The following records must be taken care of by the company:

- Test Certificates from the Workshop.
- Undownloadability certificates, see **Downloading - why? on the next page.**

Data must be available in the event of an enforcement authority investigation or audit.

## Lock-in/Lock-out Data

The company owner can lock-in tachograph data in order to make them unreachable for unauthorized persons.

We recommend that the Lock-in Data is carried out before the tachograph is being used. If Lock-in is carried out at a later time all data up to this time will be unlocked and available.

## Selling the Vehicle

In case the vehicle will be sold, a lock-out data procedure has to be performed before the vehicle is handed over to the new owner. If not there will be a risk for a mix up in the storing of data.

## When inserting a Company Card.

When a company card is inserted and the company data is not locked in, the Lock-in/out status will be shown automatically.

1. Insert a company card in tray 1 or 2. The tachograph automatically enters the company mode of operation.

If two company cards are inserted the last inserted will be ejected.

If your company does not have an active lock-in of data, a reminder to lock-in data will be shown:

**Company  
lock-in**

At this point it is possible to lock-in data (or leave data unlocked):

2. Select **YES** and press **OK**.

The following display appears for a short time:

**Lock-in  
complete**

You can later at any time show the lock-in/out status by selecting the INFO menu, see **How to reach INFO MENU on page 27.**

## Another Company still Locked-in

If a lock-in is performed and there is another company still locked-in, the tachograph will automatically perform a lock-out of the previous company. No data will be lost for any company.

## Lock-in Data

If company data is not locked-in, the Lock-in menu is shown after insertion of a company card. In addition lock-in can be carried out at any time.

1. Press the **OK** button to show the tachograph menu.
2. Select:

```
COMP LOCKS
```

3. Press **OK**.

The display will show:

```
Company  
lock-in
```

5. Select **YES** and press **OK**.

The following display appears for a short time:

```
Lock-in  
complete
```

If the last lock-out was made by the present company, that lock-out will be cancelled and the present company lock-in will be extended to the date and time for the previous lock-in.

## Note!

The tachograph is able to handle a maximum of 255 company locks. After that the oldest company lock will be removed.

## Lock-out Data

A lock-out must be performed before the tachograph is transferred to another company or if there is a risk of getting the next company's data recorded. If the lock-out is forgotten, the data will not be locked-out until the next company performs a lock-in.

1. Insert a company card in tray 1 or 2. The tachograph automatically enters the company mode of operation.

If two company cards are inserted the last inserted will be ejected.

2. Press the **OK** button to show the tachograph menu.

3. Select:

```
COMP LOCKS
```

4. Press **OK**.

5. Select **YES** and press **OK**.

The display will show:

```
Company  
lock-out
```

6. Select **YES** and press the **OK** to perform the lock-in.

The following display appears for a short time:

```
Lock-out  
complete
```

## Note!

Current company lock is printed at the bottom the technical printout.

## Downloading - why?

The available space on the cards and in the tachograph is limited and when the memory is full the information will be overwritten by new information and thereby it will be lost for ever.

To avoid this and to secure card and tachograph data a frequent download of information is needed. It means that data will be transferred from the card/tachograph to a data storage outside the vehicle.

Data has to be downloaded regularly. Please note that downloading will not

destroy any data. Data is only erased (destroyed) when it is overwritten by new data or by an accident.

### Note!

Consult the relevant authority for more information.

## Equipment

Downloading of stored data from the tachograph memory or an inserted driver card is done by attaching a download equipment compliant with the protocol as laid out in the legislative document 2016/799 (Annex 1C) Appendix 7 to the front connector.

It is also possible to perform a remote download or a download using ITS however it is not described here.

Many types of equipment can download cards directly by inserting them in a card holder on the equipment in question.

The equipment used for downloading will generate a digital signature that will be stored together with the downloaded data.

## Downloading Procedure

### Note!

If a driver card is inserted in tray 1, insert the company card in tray 2 to perform the download.

1. Remove the printer cassette.
2. Attach the download equipment to the tachograph through the 6-way front download connector.

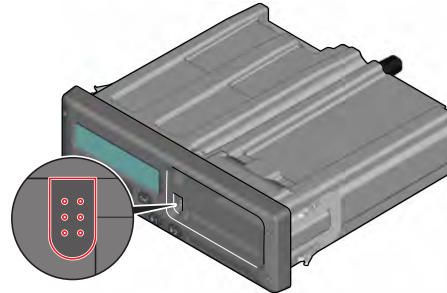

3. Start downloading data according to the instructions on the download equipment.

The tachograph will show:

`Downloading busy`

When downloading is completed, the following message will be displayed:

`Downloading complete`

If the downloading process failed the display will show the following warning:

`Download failure`

See **Display Messages** on page 59

## Keep a Record

Store all downloaded data in a secure suitable way. This will prevent unauthorised access of data.

Data must be available in the event of an enforcement authority investigation or audit.

## Certificate - when not Downloadable

If it is not possible to download data from a faulty tachograph at the workshop, they will issue a certificate of not downloadable information.

Such certificate received from a workshop must be securely stored. The certificate must be available to the enforcement

authorities during any investigation or audit.

It is good practice to keep a register of undownloadability certificates issued from a smart tachograph workshop.

### **Note!**

If a workshop receives a written request from an enforcement authority, a copy of stored downloaded data might be given to the authority for the purpose of investigation without the permission of the data owner.

### **Download with Control Card**

With a valid control card enforcement authorities can download data for investigation purposes.

### **Company Card**

Company Cards are issued by the responsible authorities in respective EU, EEA and AETR country (EU - European Union, EEA - European Economical Area, AETR - United Nation's agreement on International Road Transport). A

company may have several Company Cards.

The Company Card must be inserted in the tachograph in order to identify the company.

### **Note!**

If the tachograph fails to read the card (company card authentication), see **Display Messages on page 59** and look for:

```
Card 1auth.  
failure
```

The Company Card can be authenticated remotely. If remote authentication fails, the user will be notified by the user interface. This will not be visible on the VU-display.

The card tray is locked when the vehicle is in motion, while the tachograph is busy processing the company card and if the power supply to the tachograph is interrupted.

The Company Card can store a minimum of 230 records. The maximum number of records is dependent on the card type. When the upper limit is reached the oldest data will be overwritten.

### **Data Stored at Lock-in/out or Download**

Each time a company card is inserted into a tachograph a record of card activity is stored on the company card and in the tachograph.

- Date and time of the company activity.
- Type of activity performed.
- Period downloaded, if applicable.
- Vehicle Registration Number (VRN) and country registration authority of the vehicle used for the activity.
- Driver card number and card issuing country, in case of a card download.

### **Company Card Stored Data**

A single record of the company card activity, containing the following card and card holder information, will be stored on the company card:

- Card number.
- Issuing country, issuing authority name and the issue date.
- Card validity - start date and expiry date.
- Company name and address.

### Tachograph Stored Company Activity Data

Each time a company card is used to carry out a tachograph activity a record is stored in the tachograph.

The data stored when performing a lock-in/lock-out is:

- Lock-in date and time.
- Lock-out date and time.
- Company card number and card issuing member state.
- Company name and address.

The data stored when performing a download is:

- Date and time of the download.
- Company card number.

- Card issuing member state of the card used to perform the download.

## Company Settings

You must have a company card inserted to access the following settings.

### Show Download Process

You can select to show the Download process or blank it out.

1. Press **OK** to show the menu.
2. Select:  
`Setting`
3. Press **OK**.
4. Select:  
`Parameters`
5. Press **OK**.
6. Select:  
`Show downl. process`
7. If the process must be shown - select:  
`YES`
8. If the process not must be shown - select:  
`NO`

9. Then press **OK** to confirm.

### WTD Presentation ON/OFF

By default the WTD (Working Time Directive monitoring) is enabled (ON), but it can be switched OFF which means that not only the presentation is switched off but also all warnings associated with the WTD monitoring.

1. Press **OK** to show the menu.
2. Select:  
`SETTINGS`
3. Press **OK** and select:  
`WTD Settings`
4. Press **OK** and select:  
`WTD enable`
5. Select **OFF** to disable the WTD presentation.
6. Press **OK** to confirm. The WTD presentation is now disabled.

### D8 Data Format

1. Press **OK** to show the menu.
2. Select:  
`SETTINGS`

3. Press **OK**.
4. Select:  
`Parameters`
5. Press **OK**.
6. Select:  
`D8 data format`
7. For SRE proprietary format - select:  
`SRE`
8. For legacy format - select:  
`2400`
9. Then press **OK** to confirm.

### Set Activity when Switching Ignition Key on/off

You can select an activity to automatically be selected when switching the ignition key on or off. The activity change will apply to both the driver and the co-driver.

1. Press **OK** to show the menu.
2. Select:  
`SETTINGS`
3. Press **OK**.
4. Select:  
`Parameters`

5. Press **OK**.
6. Select one of the following (depending on which setting you wish to make):  
`Default activ. key on`  
`Default activ. key off`
7. Press **OK** to confirm.

### Set Timeout for Manual Entries

The manual entries will be closed when no interaction has been made for 1 or 20 minutes, depending on the settings. As default the timeout is 20 minutes.

1. Press **OK** to show the menu.
2. Select:  
`SETTINGS`
3. Press **OK**.
4. Select:  
`Parameters`
5. Press **OK**.
6. Select:  
`Man. entries timeout`
7. Press **OK**.
8. Select one of the following:  
`1 min`  
`20 min`

9. Press **OK**.

### Set Vehicle Registration Number (VRN)

Normally a Vehicle Registration Number (VRN) is set during installation. But if the VRN is missing you can enter it yourself. The number can only be registered once by the company.

1. Press **OK** to show the menu.
2. Select:  
`SETTINGS`
3. Press **OK**.
4. Select:  
`Reg. Number`
5. Press **OK**.
6. `Enter Reg. Number` is displayed. Press **OK**.
7. Select Country and press **OK**.
8. Select preferred character set (default set is Latin 1) and press **OK**.



9. Select the character for the first character in the vehicle registration number and press **OK**. Repeat until the complete number is entered. 13 characters can be entered.
10. Select the  symbol and press **OK**.
11. Press **OK** to confirm. The vehicle registration number is set.

### Begin and End place

The function prompting the driver to register a Begin or End place if the card is left in tachograph during the daily rest can be activated and deactivated in this menu.

If activated, you have 3 options on how long the question shall be displayed before the tachograph removes the suggestion to enter a Begin or End place.

1. Press **OK** to show the menu.
2. Select:

**SETTINGS**

3. Press **OK**
4. Select:

**Parameters**

5. Press **OK**.

6. Select **Ask working period country:**  
**Start/End reminder**

7. Select the preferred option and Press **OK**:

**OFF** - If you don't want the tachograph to suggest to register Begin or End place at ignition On/Off.

**ON** - The tachograph will prompt the suggestion and keep showing it until confirmed.

**30sec** - The tachograph will prompt the suggestion and keep showing for 30 seconds or until confirmed.

**2min** - The tachograph will prompt the suggestion and keep showing for 2 minutes or until confirmed.

- on/off - the presentation can be switched on (enabled) or switched off (disabled).
- days - is a setting for how many days in advance a warning or pre-warning shall be presented.

### DDS Settings

For the company a number of DDS settings are available, see the Table with all DDS Settings.

#### Table with all DDS Settings

This table contains all DDS settings.

## DDS Displays

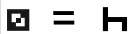
Display text	Setting	Description
DDS enable	on/off	Set if the DDS shall be shown or not shown. This is available for both driver and company.
DDS warnings	on/off	Set if the warnings and the pre-warnings shall be shown or not. This is available for both driver and company.
<b>12 Day rule</b>	YES/NO	Set if DDS shall use 12 (Yes) or 6 (No) days when calculating time until the next weekly rest. This option is available for both driver and company when the function is enabled in the tachograph.  When set to 12 (Yes) a question will appear at card insertion so the driver can confirm if they still wish to use that calculation
	break/ no break	Set if the POA (periods of availability) shall be registered as a break. This is available for company.
9h	on/off	This is a pre-warning and a warning that will be shown when the 9 hours daily driving time is near to be reached.
daily drive time	on/off	This is a pre-warning and a warning that will be shown when the maximum daily driving time is near to be reached.
weekly drive time	on/off	This is a pre-warning and a warning that will be shown when the maximum weekly driving time is near to be reached.
2-week drive time	on/off	This is a pre-warning and a warning that will be shown when the maximum 2-weekly driving time is near to be reached.
daily/weekly rest	on/off	Pre-warning and a warning for daily/weekly rest period.
card downl. interval	days	Here the company can set the number of days between card downloads.

veh. downl. interval	days	Here the company can set the number of days between tachograph download.
drive time pre-warning	hhmm	Set how many minutes (hours) in advance the tachograph will give a pre-warning. This setting affects all pre-warnings except the continuous driving time pre-warning
card expiry pre-warning	days	Set how many days in advance the tachograph will give a warning.
card downl. pre-warning	days	Set how many days in advance the tachograph will give a warning.
veh. downl. pre-warning	days	Set how many days in advance the tachograph will give a warning.
calibration pre-warning	days	Set how many days in advance the tachograph will give a warning.
Auto DDS display	on/off	In this setting the tachograph can be set to automatically show the standard display selection.

**WTD Settings**

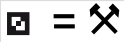
Display text	Setting	Description
WTD enable	YES/NO	Set if the WTD shall be used (enable) or not used (disable). This is only available for company.
6h	YES/NO	Set if the 6 hour pre-warning and a 6h warning shall be shown or not. This is available for company.
60h	YES/NO	Set if the 60 hour pre-warning and a 60h warning shall be shown or not. This is available for company.
	YES/NO	Period of Availability is calculated as work (YES) or not calculated as work (NO).
1st break	15,30,45	Set the length of the break to 15, 30 or 45 minutes

## Reference Part

The reference part contains additional information that sometimes may be needed but not frequently used. This part contains:

















- **Display and Printout Symbols** - contains list of symbols used in the display and on the printouts.
- **Available Languages** - a list of languages for the display.
- **Available Countries** - a list of countries that can be selected as locations.
- **Display Messages** - an alphabetically ordered list of messages, warnings and faults that can appear on the display.
- **Printout Examples** - contains the most of the possible printouts.
- **ATEX Tachograph** - a Tachograph version that is aimed for use in vehicles used for hazardous goods transports.
- **Contact Stoneridge** - how to contact Stoneridge.
- **Index**





















Keep this Driver & Company Manual in the vehicle. If the vehicle is sold, pass this manual on to the new owner as the Tachograph is considered as a part of the vehicle.





















The local Stoneridge representative will be pleased to assist you if you should have any questions. You will find a list of local representatives in chapter **Contact Stoneridge on page 93**

## Symbols

This is a list of the most frequently shown symbols on the display and on the printouts.

Symbol	Description
	Function not available
	Driver or slot
	Co-driver or slot
	Card
	Eject
	Work
	Driving / driver (Operational mode)
	Rest / break
	Available
	Ferry / train crossing
<b>OUT</b>	Out of scope, -i.e. no activities time durations are calculated
	Local time / location
	Start of daily work period
	End of daily work period
	Break
	From or to
	Printer, printout

Symbol	Description
	Paper
	Display
	Processing, please wait
	Time, clock
<b>UTC</b>	UTC time
<b>24h</b>	Daily
	Weekly
	Two weeks
	Total / summary
	Speed
	Over speeding
	Faults
	Events
	Pre-warning/question/unknown activity / undefined load type
	Workshop / calibration mode
	Company / company mode
	Controller / control mode
	Manufacturer / not activated
	Security / authenticated positions / seals
	External storage / download
	Buttons
	Finished

Symbol	Description
	Tachograph (VU), vehicle
	Tyre size
	Sensor
	Power supply
	Print
	Print, submenu
	Company lock
	Places
	Places, sub menu
	Settings
	GNSS positioning facility
	ITS interface
	Remote communication facility (DSRC)
	Load operation
	Unload operation
	Simultaneous load / unload operation
	Load type: Passengers
	Load type: Goods
	Digital map / border crossing
	Manual entry of driving activities
	RHMI

## Symbol Combinations

The following combination of symbols are the most common.

Symbols	Description
●▶	Location start of daily work period
▶●	Location end of daily work period
🕒➔	From time (UTC)
➔🕒	To time (UTC)
●🕒	Local time
🕒🕒	Crew driving
🕒	Driving time for one week
🕒	Driving time for two weeks
OUT➔	Out of scope - begin
➔OUT	Out of scope - end
🚢➔	Ferry/train mode - begin
➔🚢	Ferry/train mode - end
🕒▶	Cumulative driving time of current day
↓○	Printer low temperature
↑○	Printer high temperature
📄--	No card
🕒📄	Driver card
🔧📄	Workshop card

Symbols	Description
🏢📄	Company card
🔧📄	Control card
📄●	Control place
🚗➔	From vehicle
🕒🕒	Position after 3 hours accumulated driving time
🚗🕒	Position where the vehicle has crossed the border between two countries
🚗🕒	Position where a load operation has occurred
🚗🕒	Position where an unload operation has occurred
🚗🕒	Position where a simultaneous load/unload operations has occurred
24h🕒🔧	Daily (24h) activities from card
24h🔧	Daily (24h) activities from tachograph
!🕒🔧	Events and Faults from card
!🔧	Events and Fault from tachograph
🔧🔧	Technical data
>>🔧	Over speeding
🕒🕒🔧	Historic of inserted cards
!📄	Insertion of a non-valid card
!📄📄	Card conflict

Symbols	Description
!🕒🕒	Time overlap
!🕒📄	Driving without an appropriate card
!📄🕒	Card insertion while driving
!📄🚗	Last card session not correctly closed
>>	Over speeding
!🔧	Power supply interruption
!🕒	Motion data error
!🚗🕒	Vehicle motion conflict
!📄	Security breach
!🕒	Time conflict / time adjustment
>🔧	Over speeding control
!🕒	Absence of GNSS position
!🔧	Communication error with DSRC unit
!🕒?	GNSS Anomaly
✖📄1	Card fault (driver slot)
✖📄2	Card fault (co-driver slot)
✖📄	Display fault
✖🔧	Downloading fault
✖🔧	Printer fault
✖🕒	Sensor fault
✖🚗	VU internal fault
✖🕒	GNSS fault
✖🔧	DSRC fault

## Available Languages

When you insert your card the Tachograph automatically changes to the language on the card. But you can select any of the following languages.

Language	Language in English
Български	Bulgarian
Ceština	Czech
dansk	Danish
Deutsch	German
eesti	Estonian
Ελληνικά	Greek
English	English
español	Spanish
français	French
islenska	Icelandic
italiano	Italian
latviešu	Latvian
lietuvių	Lithuanian
magyar	Hungarian
Nederlands	Dutch
norsk	Norwegian
polski	Polish
português	Portuguese

Language	Language in English
română	Romanian
русский	Russian
slovenčina	Slovakian
slovenščina	Slovenian
suomi	Finnish
svenska	Swedish
shqip	Albanian
bosanski	Bosnian
hrvatski	Croatian
Македонски јаз	Macedonian
srpski	Serbian
Türkçe	Turkish
українська	Ukraine

## Available Countries

You can select the following countries as location on your Tachograph.

Country
Albania
Andorra
Armenia
Austria
Azerbaijan

Country
Belarus
Belgium
Bosnia/Herzegovina
Bulgaria
Croatia
Cyprus
Czech Republic
Denmark
Estonia
Faeroe Islands
Finland
France
Georgia
Germany
Greece
Hungary
Iceland
Ireland
Italy
Kazakhstan
Latvia
Liechtenstein
Lithuania
Luxembourg
Macedonia







<b>Country</b>
Malta
Monaco
Montenegro
Netherlands
Norway
Poland
Portugal
Republic of Moldova
Romania
Russian Federation
San Marino
Serbia
Slovakia
Slovenia
Spain - regions
- Andalucía
- Aragón
- Asturias
- Baleares
- Canarias
- Cantabria
- Castilla-La-Mancha
- Castilla-León
- Cataluña
- Extremadura
- Galicia

<b>Country</b>
- La Rioja
- Madrid
- Murcia
- Navarra
- País Vasco
- Valencia
Sweden
Switzerland
Türkiye
Turkmenistan
Ukraine
United kingdom , including:
- Alderney
- Guernsey
- Isle of Man
- Jersey
- Gibraltar
Uzbekistan
Vatican City
Yugoslavia
European community
Rest of Europe
Rest of the World

## Built-in Test

The built-in test can be used to check the following tachograph components for correct operation:

- Display 
- Driver card 
- Buttons 
- Printer 
- Invert display 

Perform a built-in test in the following way, but please note that the built-in test is only available when the vehicle is stationary.

1. Press the **OK** button and select:

**SETTINGS**

2. Press **OK** again.
3. Select:

**Built-in Test**

4. Press **OK**.
5. Select one of the five test categories and press **OK**.

Type of Test	Description	Action if Test Failed
□ Display	<p><b>Display test</b> The display shows positive view, negative view and a pattern of rectangles for 1 second each.</p>	<p>Visit a smart tachograph workshop to have the tachograph checked if the display is unreadable.</p> <p>If the display is unreadable the tachograph has to be decommissioned and replaced.</p>
■ Driver card	<p><b>Test of the inserted driver cards</b> There must be a driver card in the relevant slot. The name of the card holder is read and displayed for 2 seconds.</p>	<p>If a card is reported as defective, check a different card to ensure that the tachograph is functioning.</p> <p>If the tachograph seems to be defective, visit a smarttachograph workshop to have the equipment checked.</p> <p>If it is the driver card that is definitely defective, contact the responsible authority in the country where the driver card was issued.</p>
⌘ Button	<p><b>Button test</b> You are prompted to press the buttons one by one from left to right within 2 seconds of each other, otherwise the test fails.</p>	<p>Carefully clean dirty buttons with a damp cloth and a mild detergent.</p> <p>Visit a smart tachograph workshop to have the tachograph checked if a button repeatedly fails to work.</p>
▼ Printer	<p><b>Printer test</b> Prints a test page to check printer functionality.</p>	<p>Check the paper cassette, if necessary insert a new paper roll or replace the cassette.</p> <p>Visit a smart tachograph workshop to have the tachograph checked if the printer still does not work.</p>
⌘ Inverted display	<p><b>Inverted display function test</b> The display view is inverted for 2 seconds.</p>	<p>Visit a smart tachograph workshop to have the tachograph checked if the display is unreadable.</p>

**Other tests**

<b>Type of Test</b>	<b>Description</b>	<b>Action if Test Failed</b>
GNSS test	Check GNSS facility. Run " <b>Info</b> " ► " <b>GNSS live view</b> " to test the GNSS facility. If the tachograph has a current GNSS position the seconds will continuously update.	Check if any external transmitter disturbs the GNSS satellite signal. Reposition the VU to the bottom right hand side of the top shelf. Move away GSM/WiFi repeater/antennas, and third-party ECUs which power supplies may leak EMC interferences Use Optimo <sup>2</sup> to verify signal quality via HDOP value.
Other active faults	Show all currently active events and faults. Switch ignition key from off to on. Now all currently active faults will be shown.	See <b>Display Messages</b> on page <b>59</b> for actions on each fault type.







## Display Messages

There are four type of messages that can be seen on the display.

- **Messages** - contains information on processes or reminders to the driver. Messages are not stored and can not be printed. Press the **Back** button to clear the message.
- **Pre-warnings** - appear as early reminders to the warnings. Pre-warnings, except DDS and WTD related, are stored and can be printed. Press the **OK** button twice to clear the Pre-warning.
- **Warnings**- appear in the event of e.g. overspeeding or violations of the law or tachograph recording issues. Warnings are stored and can be printed. Press the **OK** button twice to clear the Warning.
- **Faults** - are more critical than warnings and are displayed if there is

a fault detected in the tachograph, in the sensor or driver card. In addition faults are presented if tampering with the equipment is detected.

Faults are stored and can be printed. Press the **OK** button to acknowledge the Fault.

Display	Description	Action
	Message Entry not possible while driving. Related to the operator.	Stop the vehicle and try the entry again.
 Absence of GNSS pos info	The VU is unable to detect any valid GNSS satellite signal for a long time	Make sure the GNSS antenna is not covered with or close to large metallic parts.  Position the VU to the bottom right hand side of the top shelf. Move any GSM/WiFi repeater/antennas, and third-party ECUs which power supplies may leak EMC interferences Use Optimo <sup>2</sup> to verify signal quality via HDOP value.
 Already in company mode	Message Two company cards inserted. The second card will be ejected without being processed (authenticated). Related to the operator.	Insert only one Company card.
 Card auth. failure	Fault The tachograph security check for the card in slot 1 failed. Similar message for slot 2. Related to the tachograph.	Perform a self test, see <b>Other tests on page 58</b>  Visit a workshop to have the equipment checked.
 Card fault	Fault The card in slot 1 is defective. Similar message for slot 2. Related to the card.	Perform a self test, see <b>Other tests on page 58</b>  Visit a workshop to have the equipment checked.
 Card time overlap	Warning The last withdrawal time of the inserted driver card is later than the date/time of the tachograph. Related to the current tachograph or the previously used tachograph.	Check the date/time of the tachograph and change if necessary.  Wait for the overlap period to elapse.

Display	Description	Action
!☐☐ Card conflict	Warning An invalid card combination has been detected. Related to the card.	Withdraw the offending card.
!☐→X☐ Card eject without saving	Message Data could not be stored on the card withdrawn from slot 2 due to an error. Similar message for slot 1. Related to the card.	Clean the card and the card slot with a soft damp cloth and try again.  Perform a self test, see <b>Other tests on page 58</b>  Visit a workshop to have the equipment checked.
☐☐☐ Card expired	Message The card in slot 1 has expired. Similar message for slot 2. Related to the operator.	Remove the card and replaced it with a valid one.
!☐☐ Card expiry	Message The card in slot 1 will expire (Day/Month) . Similar message for slot 2. Related to the operator.	Contact the responsible authority to get a new card.
!☐☐ Card ins. while driving	Warning A driver card was inserted while the vehicle was in motion. Related to the operator.	Continue the journey if the driver card is valid.
!☐←☐☐ Card integrity error	Fault Corrupt data detected when reading data from the card in slot 2 to the tachograph. Similar message for slot 1. Related to the card.	Perform a self test, see <b>Other tests on page 58</b>  Visit a workshop to have the equipment checked.
→✓ Changes saved	Message A pop-up message to confirm that a change is saved.	No further action required.

Display	Description	Action
? [ ] [ ] ▶ daily drive time	Pre-warning - 9h daily drive time Warning - 9h daily drive time Pre-warning - daily drive time Three different warnings for reaching the allowed driving time.	
! [ ] [ ] / [ ] Data integrity error	FaultThe user data stored in the tachograph has errors.Related to the tachograph	Visit a smart tachograph workshop to have the equipment checked.
↓ × ↓ Download failed	Warning A failure when trying to download data from the tachograph. Related to the tachograph/card.	Retry the download. Check the connections, the download equipment and if possibly try with another cable, and thereafter retry the download. Re-insert the card and retry the download. If possible restart the tachograph. If the tachograph is deemed faulty visit a smart tachograph workshop to have the equipment checked.
[ ] ! [ ] ↓ d/m download card	Message Indicates the time to next download of the card (Day/Month) in slot 1. Similar message for slot 2	Prepare for download.
! [ ] ↓ d/m download vehicle	Message Indicates the time to next download from the tachograph (Day/Month).	Prepare for download.



Display	Description	Action
↓✓↓ Download complete	Message The tachograph download process has been completed successfully.	No further action required.
⊠/⊠X Driving can't open slot	Message An attempt was made to open the slot while the vehicle was in motion. Related to the operator.	Stop the vehicle. The card tray can be opened only when the vehicle is stationary.
!⊠ Driving w/o valid card	Warning Driving without an appropriate card, or with an inappropriate card combination. Related to the operator.	Stop and remove inappropriate card.
!⊠▶ end of daily drive	Warning Maximum daily driving time	
!⊠  end of weekly drive	Warning Maximum weekly driving time	
!*  end of weekly work	Warning The weekly working time is reached according to the 60 h WTD rule.	
!⊠   end of 2-week drive	Warning Maximum 2-week driving time	
fnX Function not possible	Message The desired function cannot be carried out. Related to the tachograph.	Check if the tachograph is set in the correct mode of operation.  If the display still shows - Visit a smart tachograph workshop to have the equipment checked.

Display	Description	Action
!⚠ Hardware sabotage	Fault Card has been removed by force. Related to the operator.	Visit a smart tachograph workshop to have the equipment checked.
!⚠ Insertion of a non valid card	Warning A non-valid card has been inserted to a slot. Related to the operator.	Eject the non-valid card.
!⚠⚠ Last sess. not closed ok	Warning The driver card in tray 1 was ejected incorrectly during the last session.  The previous card withdrawal in tray 1 was not completed correctly by the tachograph. Similar message for slot 2. Related to the card.	Eject the card and check it visually.  Clean the card with a soft damp cloth and try again.  Still faulty - perform a self test, see <b>Built-in Test on page 56</b> .
ℓ→✓ Lock-in complete	Message The lock-in is completed.	No further action required.
←ℓ✓ Lock-out complete	Message The lock-out is completed.	No further action required.
!⌚ 30' max interruption	Indication of the remaining interruption time	
M.....! Memory full!	Message Manual entries memory full. Related to the operator.	Modify the manual entries so that the total number of entries is less.
New time? ●⌚ 03:01	Message Daylight saving time changes.	Answer <b>YES</b> to start or end daylight saving time.  Answer <b>NO</b> or press the <b>Back</b> button to cancel.

Display	Description	Action
!ATd/m next calibration	Warning Next mandatory calibration has to be carried out (d/m = Day /Month)	Plan for the calibration.
!@/T# No driver/ workshop card	Message A function has been selected that requires an inserted driver or workshop card. Related to the operator.	Visit a smart tachograph workshop to have the equipment checked.
!@? No further details	Fault An unknown type of sensor error occurred. Related to the motion sensor.	Visit a smart tachograph workshop to have the equipment checked.
>> Overspeeding	Warning The vehicle speed has exceeded the speed limit set for 1 minute and will be stored. Related to the operator.	Observe the specified speed limit.  Find out the maximum speed allowed for the vehicle.
>>? Overspeeding pre-warning	Warning The vehicle is exceeding the over speed limit.  After 1 (one) minute of continuous over speeding the warning will be stored. Related to the operator.	Observe the specified speed limit.

Display	Description	Action
!⚡ Power supply interruption	<p>Warning</p> <p>The tachograph supply voltage is below or above the limit for correct operation or has been disconnected. Related to the vehicle.</p> <p>Warning</p> <p>The power supply to the tachograph has been interrupted for more than 200 milliseconds. Cranking voltage should not cause this event. The event is not generated in calibration mode. Related to the vehicle.</p>	<p>Visit a smart tachograph workshop to have the equipment checked.</p>
▼↑☐ Printer high temperature	<p>Message</p> <p>The printing could not start, or the ongoing printing has been interrupted, because the temperature of the printer is too high. Related to the printer.</p>	<p>Wait until the printer temperature is in allowable range and try to print again.</p> <p>Visit a smart tachograph workshop to have the equipment checked.</p>
▼↓⚡ Printer low power	<p>Message</p> <p>The ongoing printing has been interrupted because the tachograph input voltage is too low. Related to the vehicle.</p>	<p>Check that the ignition is on.</p> <p>Check the vehicle battery voltage, connections, etc.</p> <p>If the printer still is faulty - Visit a smart tachograph workshop to have the equipment checked.</p>
▼↓☐ Printer low temperature	<p>Message</p> <p>The printing could not start because the temperature of the printer is too low. Related to the printer.</p>	<p>Wait until the printer temperature is in allowable range and try to print again.</p> <p>If the printer still is faulty - Visit a smart tachograph workshop to have the equipment checked.</p>

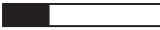
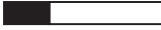
Display	Description	Action
▼PX Printer out of paper	Message The ongoing printing has been interrupted because the printer is out of paper.	Replace paper.
Printing busy 	Message The printing is ongoing.	Wait until the printout is finished.  Press and hold the Back button to cancel the printout
Cancelling printing 	Message The ongoing printing is being cancelled.	No further action required.
▼✓▼ Printing complete	Message The ongoing printing has been completed.	No further action required.
>4 1/2h? Quarter left reminder	Message The driver has 15 minutes left until the legal maximum continuous driving time of 4½ hours will be exceeded.	Find a suitable place to take a break in the next 15 minutes.
?*6h reminder break	Pre-warning A reminder for a break according to the 6 h WTD rule.	
?▶1h reminder daily rest	Pre-warning A reminder for the daily rest.	
!▶1hh reminder weekly rest	Pre-warning A reminder for the weekly rest.	
XY Remote Detection fault	Fault Cannot communicate with the Remote Detection facility (DSRC)	Visit a smart tachograph workshop to have the equipment checked.

Display	Description	Action
!@AX Security violation	Tampering with hardware has been detected	Visit a smart tachograph workshop to have the equipment checked.
!@ sensor auth. failure	Fault The tachograph does not detect the sensor. Related to the motion sensor.	Visit a smart tachograph workshop to have the equipment checked.
!@ sensor auth. failure	Fault The tachograph does not recognise the connected sensor as the one installed. Related to the motion sensor.  Fault An unsuccessful authentication attempt of the motion sensor has been detected. Related to the motion sensor.	Visit a smart tachograph workshop to have the equipment checked.
! sensor cable fault	Warning No pulses received from motion sensor, but encrypted data is received. Related to the motion sensor.	Visit a smart tachograph workshop to have the equipment checked.
! sensor cable fault	Warning Pulses received from motion sensor, but encrypted data missing or mismatch. Related to the motion sensor.	Visit a smart tachograph workshop to have the equipment checked.
X sensor comms error	Fault Motion sensor communication error. Related to the motion sensor.	Visit a smart tachograph workshop to have the equipment checked.

Display	Description	Action
!⏏ Sensor data error	Warning Signal failure between motion sensor and tachograph. Related to the motion sensor.	Visit a smart tachograph workshop to have the equipment checked.
!⏏/⏏ Sensor data integrity error	Fault Internal motion sensor error, stored data integrity failure. Related to the motion sensor	Visit a smart tachograph workshop to have the equipment checked.
×⏏⏏ Sensor no acknowledge	Fault Motion sensor communication error. Related to the motion sensor.	Visit a smart tachograph workshop to have the equipment checked.
×⏏←⏏ Sensor no answer	Fault The motion sensor and tachograph do not communicate. Related to the motion sensor.	Visit a smart tachograph workshop to have the equipment checked.
!⏏⏏ Sensor no power signal	Fault Motion sensor has no power. Related to the motion sensor.	Visit a smart tachograph workshop to have the equipment checked.
×⏏⏏⏏↑ Sensor power high	Fault Motion sensor power too high. Related to the motion sensor.	Visit a smart tachograph workshop to have the equipment checked.
×⏏⏏⏏↓ Sensor power low	Fault Motion sensor power too low. Related to the motion sensor.	Visit a smart tachograph workshop to have the equipment checked.
⏏→⏏? Service pre-warning	Message Next calibration, pre-warning.	Visit a smart tachograph workshop to have the equipment checked.
!⏏⏏ Time conflict GNSS versus UU	Message The internal clock and the GNSS clock differs more than 1 minute	Make sure the GNSS antenna is not covered or that the GNSS signal is distorted.

Display	Description	Action
>4 1/2h Time for break	Message The legal maximum continuous driving time of 4½ hours has elapsed.	
!*6h time for break	Warning Take a break according to the 6 h WTD rule	Minimum break 15 min
!▶1h time for daily rest	Warning A warning for start of daily rest.	
!A→T Time for service	Message The tachograph is out of calibration.	Visit a smart tachograph workshop to have the equipment checked.
!▶1hh time for weekly rest	Warning A warning for start of weekly rest.	
☐→☐ Timeout no key pressed	Message The tachograph is waiting for input. Timeout 1 min or 20 min.	Press the appropriate buttons and complete the process. Timeout can be changed in Settings menu.
X☐/☐/☐X Unable to open slot	Message The card tray concerned cannot be opened. Related to the tachograph.	<p>Check that the ignition is on.</p> <p>Power cycle the unit and check that the card is successfully ejected.</p> <p>Clean the card and the card slot with a soft damp cloth and try again.</p> <p>If the tray is still faulty - Visit a smart tachograph workshop to have the equipment checked.</p>
!☐☐☐ Unauth. change of sensor	Fault The sensor has been changed since last pairing. Related to the motion sensor.	Visit a smart tachograph workshop to have the equipment checked.



Display	Description	Action
!A Z X Unauth. VU opening	Fault The Tachograph unit case has been opened. Related to the tachograph.	Visit a smart tachograph workshop to have the equipment checked.
!A U Vehicle Motion Conflict	Message GNSS motion sensor and primary motions sensor data contradicts. Related to the motion sensor.	Check DTCs to verify which of the triggers that create the event.  Check GNSS equipment, is anything interfering with the GNSS signal?  Visit a smart tachograph workshop to have the equipment checked.
!B 12/10 VU expiry	Warning The tachograph (VU) will expire as per legal at the displayed date.	Visit a smart tachograph workshop to replace the tachograph
X A VU internal fault	Fault The tachograph has detected an internal fault. Related to the tachograph.	Visit a smart tachograph workshop to have the equipment checked.
?@ weekly drive time	Pre-warning Maximum weekly driving time	
?* weekly work time	Pre-warning Reaching the weekly working time according to the 60 h WTD rule.	
?@ 2-week drive time	Pre-warning Maximum 2-week driving time	

Display	Description	Action
!#? GNSS Anomaly	Fault GNSS receiver has detected an attack, or failed in authenticating messages.	Check for evidence of tampering with the unit, or devices interfering with the reception around the tachograph. Restart the tachograph, verify if the GNSS receiver still reports anomalies.
!⊗ Pairing Failed	Message The ITS pairing with a device has failed.	
!⊗ Pairing Complete	Message The ITS pairing with a device has completed successfully.	
!⊗ RHMI Pairing Failed	Message The RHMI pairing with a device has failed.	
!⊗ RHMI Pairing Complete	Message The RHMI pairing with a device has completed successfully.	
RHMI TOKEN 12345678	Message The RHMI pairing requires confirmation from a device.	
RHMI Manual entries ongoing...	Message Manual entries via RHMI are currently taking place.	
RHMI Manual entries aborted!	Message Manual entries via RHMI have been aborted.	
B+B VU Update available	Message The VU has detected that there is a software update available.	

## Printout Examples

On the following pages there are a number of printout examples that can be selected from the **PRINT** menu:

- Daily printout (card) **24h card** (including local time).
- Daily printout (VU) **24h vehicle** (including local time).
- Event and faults (card) **event card**.
- Event and faults (VU) **event vu**.
- Drive Time Info **drive time info**
- Technical data **technical data**.
- Overspeeding **overspeeding**.
- Vehicle speed **vehicle speed**.
- Engine speed (rpm) **engine speed**.
- Status D1/D2 **status D1/D2**.
- Manual Entry Sheet **man entry sheet**.

### Generation 1

User selected to print Gen 1 data from the card

```

▼▼▼ GEN1 ▼▼▼
▼ 22/10/2022 08:04 (UTC)
-----▼-----

```

### Generation 2

User selected to print Gen 2 data from the card

```

▼▼▼ GEN2 ▼▼▼
▼ 22/10/2022 08:04 (UTC)
-----▼-----

```

- If card is Gen2 v1, it does not include any Gen2 v2 data.
- If card is Gen2 v2, it includes Gen2 v1 and Gen2 v2 data.

## Daily Printout (card) (1/2)

This printout lists all activities stored on the driver card (or codriver card) for the selected date (legal requirement). UTC time is used.

The display shows the following (on the second line):

### 24h card

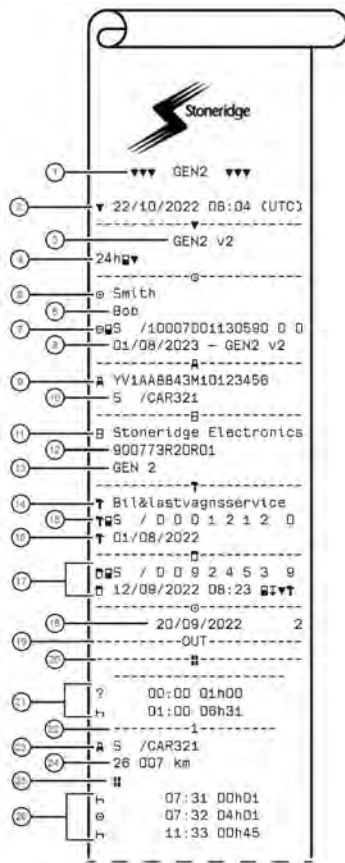

1. Type of data printed, GEN1 or GEN2
2. Printout date and time
3. Printout from a GEN2 v2 VU
4. Type of printout (24h, card)
5. Card holder's surname
6. Card holder's first name
7. Type of card, Issuing country, and Card number
8. Card expiry date, Generation and version
9. Vehicle identification number (VIN)
10. Country of registration, and Vehicle registration number (VRN)
11. Tachograph manufacturer
12. Tachograph part number
13. Tachograph generation
14. Workshop responsible for last calibration
15. Workshop card, Issuing country, Card number
16. Date of last calibration
17. Control card, Issuing country, Card number, Last inspection the driver experienced, type of VU action by enforcer
18. Date printed and Card daily presence counter
19. Printed if Out of Scope was active at insertion of card
20. Load type of vehicle if card was as left inserted over night
21. Manually entered activities (Unknown, and Rest)
22. Slot in which card was inserted
23. Country of registration and VRN
24. Vehicle odometer at card insertion
25. Load type of the vehicle (Goods or Passenger)
26. Activity type, Start time, and duration of the activity

## Daily Printout (card) (2/2)

To make it easier to check the activities on the printout you can select local time instead of UTC. The printout contains in all other respect the same information.

### Note!

The text **OUT OF REGULATION** indicates that this printout doesn't comply with any regulation.

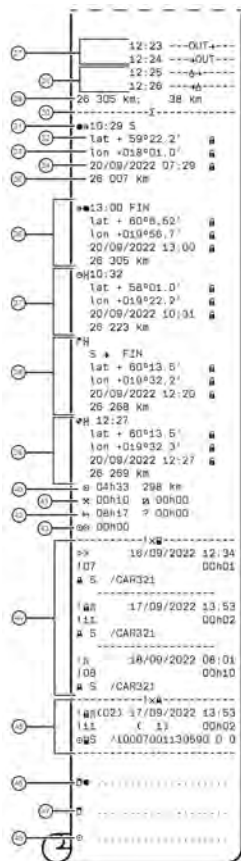
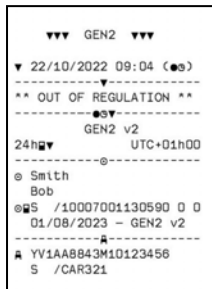

27. Out of Scope Started, Out of Scope Ended
28. Ferry/Train Started, Ferry/Train Ended
29. Vehicle odometer at withdrawal and distance travelled since last insertion
30. Summary block indicator
31. Time and Country (and region if applicable) at start of daily working period
32. Latitude at start of daily working period, Authentication status
33. Longitude at start of daily working period, Authentication status
34. Date and time of latest position, Authentication status
35. Odometer at start of daily working period
36. End of daily working period record
37. 3 hours of accumulated driving record
38. Border crossing record with Country left, Country entered
39. Load operation record (Load, Unload, Simultaneous Load/Unload)
40. Total driving duration and distance
41. Total duration of the activities, **Work**, and **Available**
42. Total duration of the activities, **Rest**, and **Unknown**
43. Total duration of crew activities
44. Events and faults from the card
45. Events and faults from the VU
46. Control place
47. Controllers signature
48. Driver's signature

### Daily Printout (VU) (1/3)

This printout lists all activities stored in the tachograph (VU) for the selected date (legal requirement). UTC time is used.

The printout is dependent of the following:

- If no card is inserted, select either the current day or any of the eight previous calendar days.
- When a card is inserted, select any day stored in the tachograph, out of a maximum of typically the most recent 28 days. If no data is available for the selected date, the printout will not be initiated.

The display shows the following (on the second line):

#### 24h vehicle

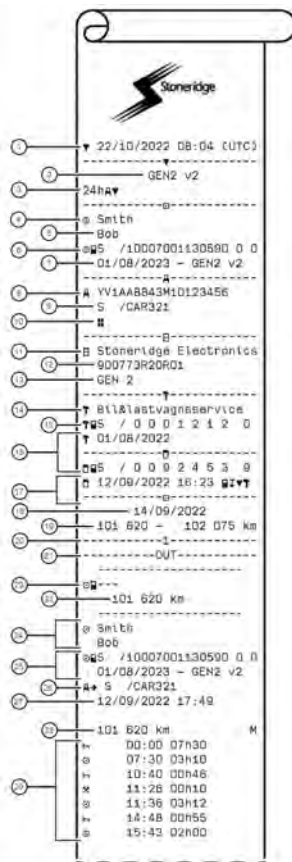

1. Printout date and time
2. Printout from a GEN2 v2 VU
3. Type of printout (24h, VU)
4. Card holder's surname
5. Card holder's first name
6. Type of card, Issuing country, and Card number
7. Card expiry date, Generation and version
8. Vehicle identification number (VIN)
9. Country of registration, and Vehicle registration number (VRN)
10. Load type of the vehicle (Goods or Passenger)
11. Tachograph manufacturer
12. Tachograph part number
13. Tachograph generation
14. Workshop responsible for last calibration
15. Workshop card, Issuing country, Card number
16. Date of last calibration
17. Control card, Issuing country, Card number, Last inspection the vehicle experienced, type of VU action by enforcer
18. Date printed
19. Vehicle odometer at 00:00, and at 24:00
20. Slot relevant for below activities
21. Printed if Out of Scope was active at beginning of day
22. Indicator that below information is when there was no card present
23. Odometer at the beginning of the following activities
24. Driver's surname and first name
25. Type of card, Issuing country, Card number, Card expiry date, Generation and version
26. Country of registration, and Vehicle registration number of the vehicle where the card was last inserted
27. Date and time of card withdrawal from previous vehicle
28. Vehicle odometer at card insertion, and indicator (M) if driver performed manual entries
29. Activity type, Start time, and duration of the activity

## Daily Printout (VU) (2/3)

To make it easier to check the activities on the printout you can select local time instead of UTC. The printout contains in all other respect the same information.

### Note!

The text OUT OF REGULATION indicates that this printout doesn't comply with any regulation.

```

vvv GEN2 vvv
v 22/10/2022 09:04 (●●)
-----v-----
** OUT OF REGULATION **
-----v-----
●●v-----
GEN2 v2
24h▼ UTC+01h00
-----v-----
@ Smth
  Bob
@S /10007001130590 0 0
01/08/2023 - GEN2 v2
-----v-----
A YV1A8843M10123456
S /CAR321
  #
  
```

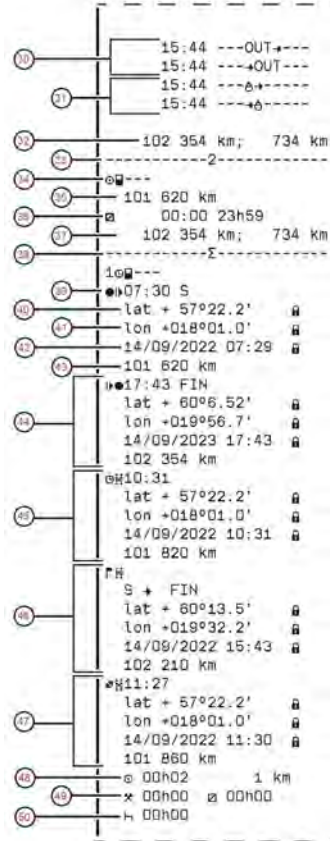

30. Out of Scope Started, Out of Scope Ended
31. Ferry/Train Started, Ferry/Train Ended
32. Vehicle odometer at withdrawal and distance travelled since last insertion
33. Slot relevant for below activities
34. Indicator that below information is when there was no card present
35. Odometer at the beginning of the following activities
36. Activity type, Start time, and duration of the activity
37. Vehicle odometer at withdrawal and distance travelled during the no card period
38. Summary block indicator
39. Time and Country (and region if applicable) at start of daily working period
40. Latitude at start of daily working period, Authentication status
41. Longitude at start of daily working period, Authentication status
42. Date and time of latest position, Authentication status
43. Odometer at start of daily working period
44. End of daily working period record
45. 3 hours of accumulated driving record
46. Border crossing record with Country left, Country entered
47. Load operation record (Load, Unload, Simultaneous Load/Unload)
48. Total driving duration and distance travelled
49. Total duration of the activities, **Work**, and **Available**
50. Total duration of the activity, **Rest**

Daily Printout (VU) (3/3)

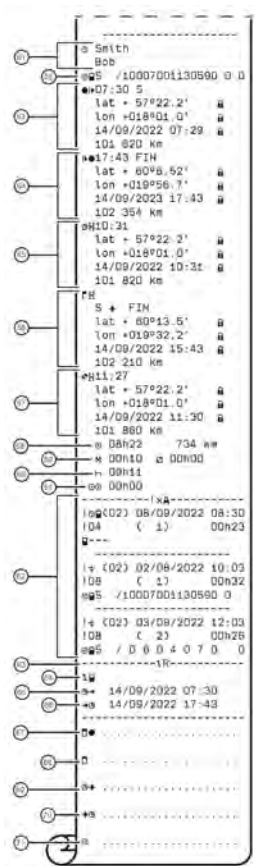

51. Driver's surname and first name
52. Type of card, Issuing country, Card number
53. Start of daily working period record
54. End of daily working period record
55. 3 hours of accumulated driving record
56. Border crossing record with Country left, Country entered
57. Load operation record (Load, Unload, Simultaneous Load/Unload)
58. Total driving duration and distance
59. Total duration of the activities, Work, and Available
60. Total duration of the activities, Rest
61. Total duration of crew activities
62. Last five events and/or faults from the VU
63. Remote HMI session block
64. Indicator for which slot the session was active
65. Start time of the Remote HMI session
66. End time of the Remote HMI session, omitted if still ongoing
67. Control place
68. Controllers signature
69. From time
70. To time
71. Driver's signature



## Events and Faults (card)

This printout lists all warnings and faults stored on the card (legal requirement). UTC time is used.

The display shows the following (on the second line):

**event card**

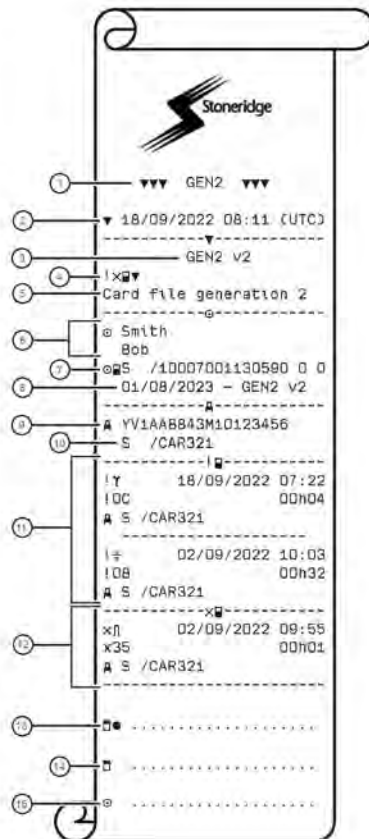

1. Type of data printed, GEN1 or GEN2
2. Printout date and time
3. Printout from a GEN2 v2 VU
4. Type of printout (Events and Faults, card)
5. Card file system (generation 1 or 2)
6. Card holder's surname, and first name
7. Type of card, Issuing country, and Card number
8. Card expiry date, Generation and version
9. Vehicle identification number (VIN)
10. Country of registration, and Vehicle registration number (VRN)
11. List of all events stored on the card
12. List of all faults stored on the card
13. Control place
14. Controllers signature
15. Driver's signature

## Events and Faults (VU)

This printout lists all warnings and faults stored in the tachograph or vehicle unit (legal requirement). UTC time is used.

The display shows the following (on the second line):

```
event vehicle
```

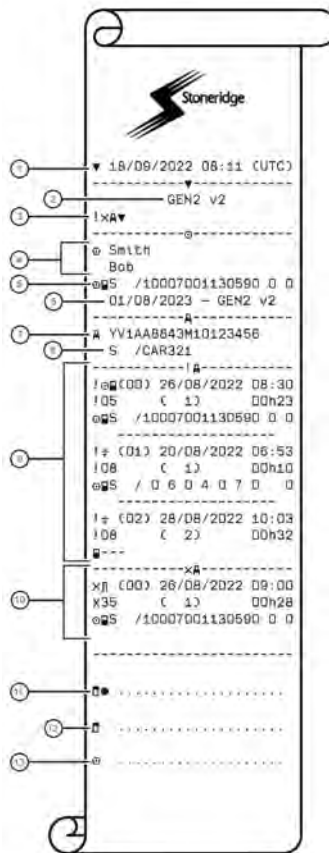

1. Printout date and time
2. Printout from a GEN2 v2 VU
3. Type of printout (Events and Faults, VU)
4. Card holder's surname, and first name
5. Type of card, Issuing country, and Card number
6. Card expiry date, Generation and version
7. Vehicle identification number (VIN)
8. Country of registration, and Vehicle registration number (VRN)
9. List of all events stored in the VU
10. List of all faults stored in the VU
11. Control place
12. Controllers signature
13. Driver's signature

## Drive Time Info

This printout lists drive time information.

The display shows the following (on the second line):

```
drive time info
```

### Note!

Point. 8: The question mark after the value indicates that UNKNOWN periods have been assimilated to BREAK/REST.

### Note!

Point 17 through 22: These summary lines are only printed if there are any warnings present.

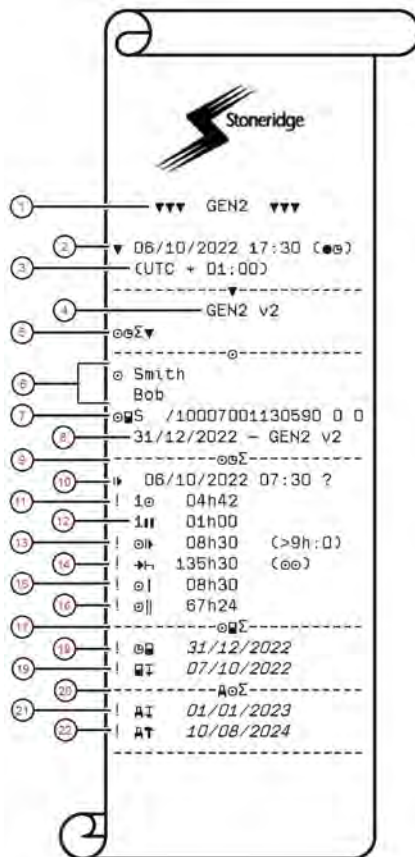

1. Type of data printed, GEN1 or GEN2
2. Printout date and time
3. Shows the time difference between UTC and local time.
4. Printout from a GEN2 v2 VU
5. Type of printout (Driver's time summary)
6. Card holder's surname, and first name
7. Type of card, Issuing country, and Card number
8. Card expiry date, Generation and version
9. Driver's time summary
10. End of the last daily/weekly rest period.
11. Driver's continuous driving time.
12. Driver's accumulated break time.
13. Daily driving time, in parenthesis - the number of times when the driving time has exceeded 9 hours during the current week.
14. Time left before the driver must start the daily/weekly rest period.
15. Weekly driving time.
16. Two weeks driving time.
17. Driver card summary.
18. Driver card expiry date.
19. Date of the next mandatory driver card download.
20. Vehicle unit (tachograph) related times summary.
21. Date of the next mandatory VU download.
22. Date of the next mandatory VU calibration.

## Technical Data (1/2)

This printout list data as speed settings, tyre size, calibration data and time of adjustments.

The display shows the following (on the second line):

**technical data**

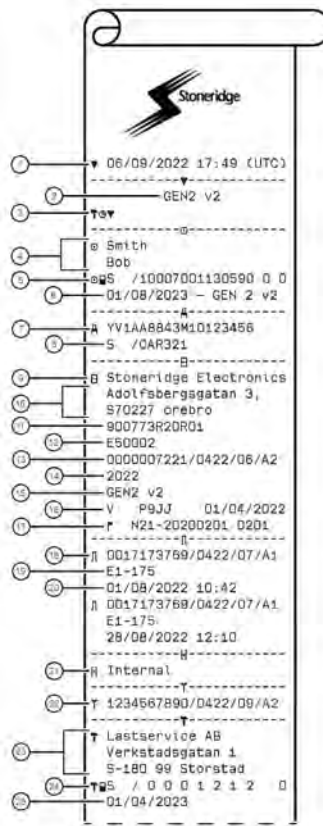

1. Printout date and time
2. Printout from a GEN2 v2 VU
3. Type of printout (Technical data)
4. Card holder's surname, and first name
5. Type of card, Issuing country, and Card number
6. Card expiry date, Generation and version
7. Vehicle identification number (VIN)
8. Country of registration, and Vehicle registration number (VRN)
9. VU manufacturer
10. Address of VU manufacturer
11. VU part and variant number
12. VU type approval number
13. VU extended serial number
14. Year of manufacturing
15. VU generation and version
16. VU software version and installation date
17. Digital map version, and Stoneridge map version
18. Sensor extended serial number
19. Sensor type approval number
20. Sensor pairing date and time
21. Information that the GNSS receiver is internal in the VU
22. DSRC extended serial number
23. Name and address of the workshop that performed the calibration of the VU
24. Type of card, Issuing country, and Card number
25. Card expiry date, Generation and version

## Technical Data (2/2)

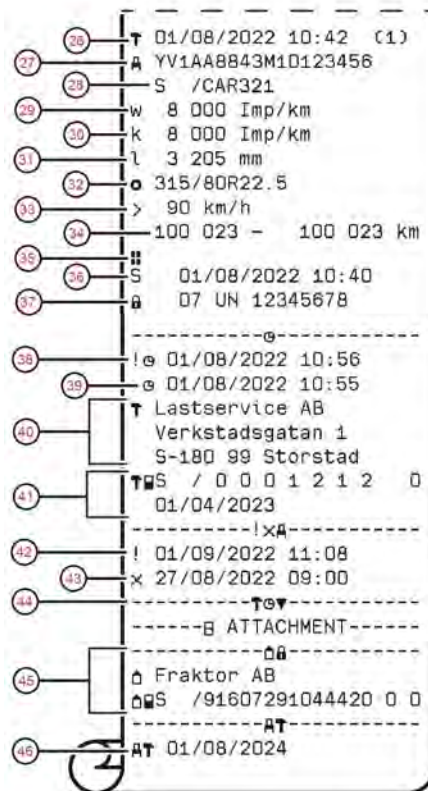

26. Date and time of calibration, and calibration purpose.  
Calibration purposes:
1. Activation (parameters when VU was activated)
  2. First calibration of the VU after activation
  3. First calibration in a new vehicle
  4. Periodic inspection
  5. Entry of vehicle registration number by company
  6. Time adjustment without calibration
27. Vehicle identification number
28. Country of registration, and Vehicle registration number (VRN)
29. W-factor, the characteristic coefficient of the vehicle
30. K-factor, the constant of the VU
31. L-factor, the effective circumference of the tyres
32. Vehicle tyre size
33. Authorized speed of the vehicle
34. Old odometer value - new odometer value
35. Load type of the vehicle (Goods or Passenger)
36. Country where the calibration has been performed, time and date for the GNSS position data
37. Seal data (up to five seals) - Equipment sealed, manufacturer code, serial number
38. Old date and time (before time adjustment)
39. New date and time (after time adjustment)
40. Workshop that updated the UTC
41. Type of card, Issuing country, Card number and Card expiry date
42. Most recent event date and time
43. Most recent fault date and time
44. End of legally required printout data
45. Company lock (Company name and card data)
46. Next calibration date of the VU

## Overspeeding

This printout lists overspeeding events together with duration and the name of the driver.

The display shows the following (on the second line):

**overspeeding**

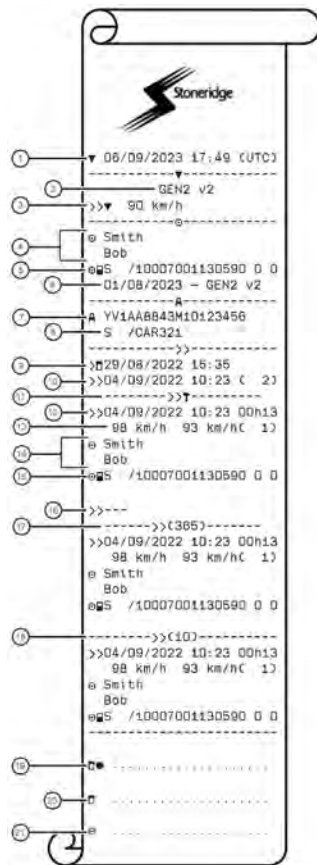

1. Printout date and time
2. Printout from a GEN2 v2 VU
3. Type of printout (Over speeding), and authorized speed
4. Card holder's surname, and first name
5. Type of card, Issuing country, and Card number
6. Card expiry date, Generation and version
7. Vehicle identification number (VIN)
8. Country of registration, and Vehicle registration number (VRN)
9. Date and time of last over speeding control
10. First over speeding and number of over speeding events since
11. First over speeding after last calibration
12. Date, time and duration
13. Max and average speed, and number of similar events this day
14. Driver's surname, and first name
15. Type of card, Issuing country, and Card number
16. If no over speeding events exists this line would be printed
17. The 5 most serious over speeding events in the last 365 days
18. The most serious for each of the last 10 days of occurrence
19. Control place
20. Controller's signature
21. Driver's signature

## Vehicle Speed

This printout lists the vehicle speed organized chronologically in speed bands (km/h) for each driver.

The display shows the following (on the second line):

```
vehicle speed
```

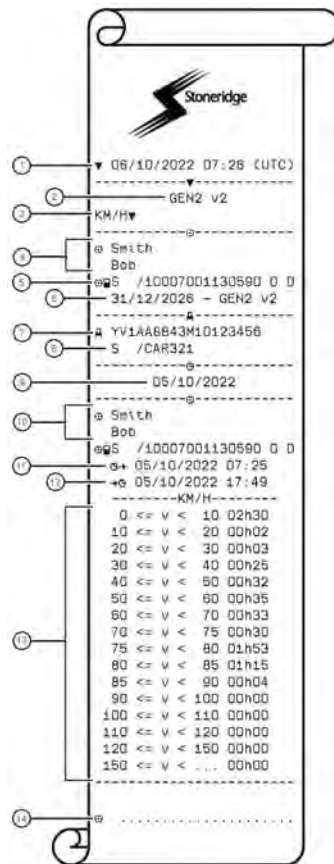

1. Printout date and time
2. Printout from a GEN2 v2 VU
3. Type of printout (vehicle speed)
4. Card holder's surname, and first name
5. Type of card, Issuing country, and Card number
6. Card expiry date, Generation and version
7. Vehicle identification number (VIN)
8. Country of registration, and Vehicle registration number (VRN)
9. Date printed
10. Information about previous driver (In chronological order)
11. Previous drivers start date and time
12. Previous drivers end date and time
13. Speed band and duration time
14. Driver's signature

## Engine Speed (rpm)

This printout lists the vehicles engine speed in bands of rpm in chronological order for each driver.

The display shows the following (on the second line):

**engine speed**

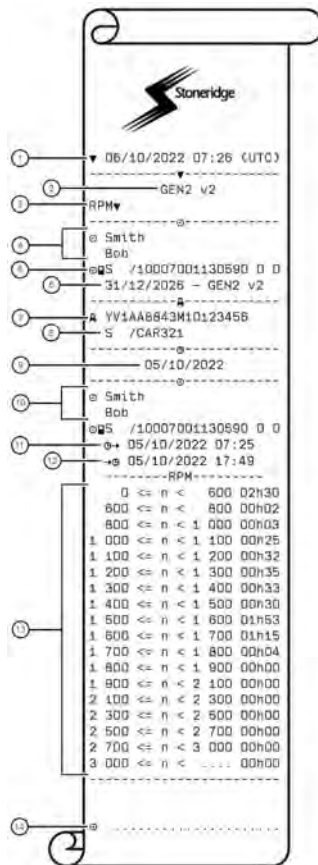

1. Printout date and time
2. Printout from a GEN2 v2 VU
3. Type of printout (engine speed)
4. Card holder's surname, and first name
5. Type of card, Issuing country, and Card number
6. Card expiry date, Generation and version
7. Vehicle identification number (VIN)
8. Country of registration, and Vehicle registration number (VRN)
9. Date printed
10. Information about previous driver (In chronological order)
11. Previous drivers start date and time
12. Previous drivers end date and time
13. Speed band of engine and duration time
14. Driver's signature



## Status D1/D2

This printout lists the changes of status of the rear connectors (D1 and D2).

The display shows the following (on the second line):

**status D1/D2**

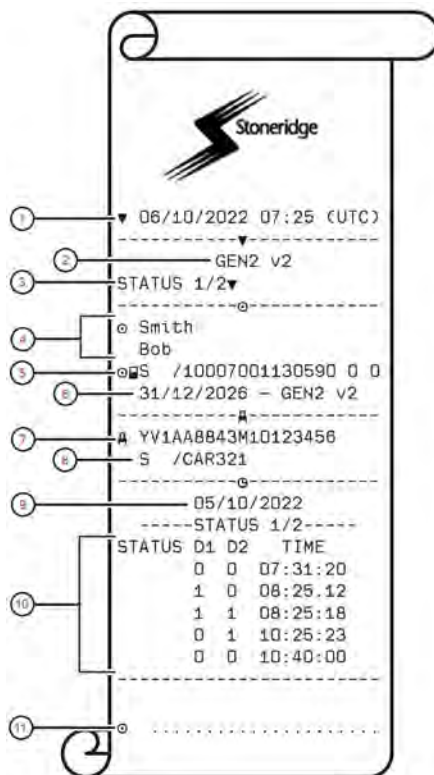

1. Printout date and time
2. Printout from a GEN2 v2 VU
3. Type of printout (Status D1/D2)
4. Card holder's surname, and first name
5. Type of card, Issuing country, and Card number
6. Card expiry date, Generation and version
7. Vehicle identification number (VIN)
8. Country of registration, and Vehicle registration number (VRN)
9. Date printed
10. Changes of status for the connectors and timestamp
11. Driver's signature

## Manual Entry Sheet

This is a printout sheet for hand writing of data.

The display shows the following (on the second line):

**man entry sheet**

### Note!

If there is no card inserted in the slot selected point 4 trough to 6 will be pictogram followed by ----- and point 9 and 11 will not be present.

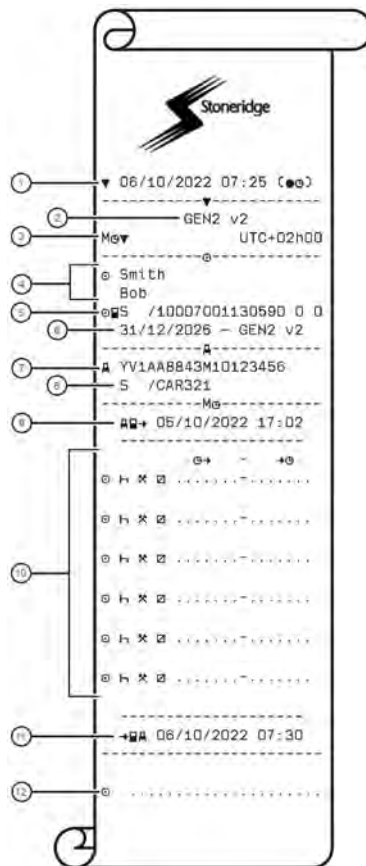

1. Printout date and time
2. Printout from a GEN2 v2 VU
3. Type of printout (Manual Entry Sheet) and UTC offset
4. Card holder's surname, and first name
5. Type of card, Issuing country, and Card number
6. Card expiry date, Generation and version
7. Vehicle identification number (VIN)
8. Country of registration, and Vehicle registration number (VRN)
9. Date and time of last card withdrawal
10. Area for the driver to enter manual entries with duration time
11. Date and time of card insertion
12. Driver's signature

## Data and Specifications

### DDS Calculations and Limits

DDS does a *best effort* calculation to support drivers and fleets in their compliance with Regulation (EC) 561/2006. Stoneridge shall not be held responsible for any defects or shortcomings in this function.

DDS generally takes the following into account in its internal calculations:

- Activity data on driver card.
- General requirements in Regulation (EC) 561/2006 on drive time, breaks, rests and calendar weeks.
- Requirements in the Working Time Directive 2002/15/EC.
- Includes calculation of Ferry/Train travelling time.
- Time of the VU internal clock, in the UTC time zone.

The data presented by DDS may in some cases differ from what regulation states or how it may be interpreted by some control

officers, especially in (but not limited to) some special cases:

- Periods of driving mixed between analogue and smart tachographs, with new driver cards or without driver cards, in which case relevant data may be missing on the driver card.
- Extremely frequent activity changes.
- Malfunctioning driver card.
- Some uses of Out of Scope special conditions.
- Driving in non-EU AETR countries.
- International coach bus transports where the 12 day derogation applies.
- Other exceptions where Regulation (EC) 561/2006 does not apply.
- Use of compensatory weekly rest.
- Certain combinations of reduced and regular weekly rests starting and ending in separate calendar weeks.
- Optional use of AVAILABILITY activity for breaks.
- Large deviations in time adjustment between vehicle units where the driver card has been inserted.

- Multi-manning when drivers have started their daily working periods at separate times.

### DDS in Details

This table reflects what the DDS covers and not covers.

Type	Support YES/NO
Daily driving time 4.5 + 4.5h	YES
Extended driving time 10h	YES
Number of extended driving times during a 2-week period	YES
Daily break 45 min	YES
Divided break 15-30 min	YES
Daily rest 11h	YES
Reduced daily rest 9h	YES
Split daily rest 3+9h	YES
Number of reduced daily rests since last weekly rest (max 3)	YES
Max interval between daily rests (24h if single driver)	YES
Weekly driving time 56h	YES
2-week driving time 90h	YES
Weekly rest 45h	YES

Reduced weekly rest 24h	YES
Max interval (144h since end)	YES
Assigning to one week	YES
Multi-manning	YES
Regular/reduced rests in two week period (1+1)	YES
12 days derogation rule for international bus transports.	YES (if enabled)
Compensatory weekly rest.	NO
Working time directive.	YES
Interruptions of daily rest for ferry/train, e.g. driving on or off a ferry or train	YES
Interruptions of weekly rest for ferry/train, e.g. driving on or off a ferry or train	YES
AETR specific rules	NO

**Note!**

All calculations are based on fixed weeks in UTC time and not on local time weeks.

**Certification and Approval**

The tachograph is approved for use in the European Union and certified to Common Criteria level EAL4+ in accordance with EU legislation.

**Avoid High Voltage**

Interrupt the power supply to the tachograph if you expect that the vehicle will require several jump-starting attempts, or before carrying out welding work.

For more information on how to interrupt the tachograph power, see the vehicle’s operating manual.

It might be necessary to re-calibrate the tachograph if the power is interrupted.

**Note!**

High voltage may lead to permanent tachograph damage and to failure of the tachograph’s electronic components. Damage to the tachograph caused in this way invalidates the warranty.

**Data stored in the Tachograph**

The tachograph records and stores various data:

- Driver card data, except from driving license data.
- Warnings and malfunctions related to the tachograph and the driver, company and workshop cards.
- Vehicle information, odometer data and detailed speed for 24 hours.
- Tampering with the tachograph.
- Vehicle speed is stored continuously.
- Tachograph generation.
- Driver consent
- Bluetooth pairing
- RHMI allowance

**Note!**

Over speeding for more than one minute will be stored in the tachograph.

*Insertion and Withdrawal Data*

Data stored for each driver card:

- Card holder's surname and first name.
- Driver card number, card issuing member state and the card expiry date.
- Date and time at driver card insertion and withdrawal.
- Vehicle odometer value at driver card insertion and withdrawal time.
- The vehicle registration number and registering member state of the vehicle.
- Vehicle position
- Card withdrawal time for the last vehicle in which the driver card was inserted.
- In which tray the driver card is inserted.
- Indication if manual entries of activities have been made.
- Driver's tachograph language choice.

### *Driver Activity Data*

Data stored for each day and change of driving activity:

- Driving status: single or part of a crew.
- Card tray used in the tachograph.
- Card inserted or not inserted at the time of change of activity.
- Driver activity.
- Date and time of activity change.

### *Other Data*

Other data stored in the tachograph:

- Detailed vehicle speed.
- Vehicle overspeeding for at least 1 minute.
- Company and workshop events
- Vehicle position at every three hours of accumulated driving

### **Data stored on the Card**

The driver card is unique for each driver and therefore it identifies the card holder. In addition the card stores various data:

- Driving time, activities and distance.
- Drivers license information.
- Some warnings and malfunctions.

- Vehicle Registration Number (VRN) for vehicles used by the card holder.
- Controls performed by authorities.

Data is stored automatically on the card, when so is needed. In a co-driver operation, data for both driver and co-driver are stored on the cards respectively. The tachograph supports both generation 1 and generation 2 cards.

### **Note!**

**Cards will store as much data as possible based on the technical requirements for card manufacturers. After this time, the oldest data is overwritten when new data is stored.**

### *Insertion and Withdrawal Data*

Data stored for each day and vehicle:

- Date and time for the first driver card insertion and last withdrawal.
- Vehicle odometer value at first driver card insertion and last withdrawal.

- The vehicle registration number and registering member state of the vehicle.
- Vehicle position
- Vehicle type, goods or passenger

### *Driver Activity Data*

Data stored for each day and change of driving activity:

- Date and daily presence counter.
- The total distance travelled by the driver card holder.
- The driving status at every midnight or at card insertion, single driver or part of a crew.
- A record of each driving activity change.
- Driving status: driver or co-driver.
- Card tray used in the tachograph.
- Card inserted or not inserted at the time of change of activity.
- Driver activity.
- Date and time of activity change.
- Vehicle position at every three hour of accumulated driving

### **Electromagnetical Compatibility**

The tachograph fulfils the requirements of UNECE regulation number 10, revision 05, in respect of electromagnetic compatibility.

### **Operating Temperature**

–25°C to +70°C

Hazardous goods version in accordance with ADR: –25°C to +65°C.

## ATEX Tachograph

### Hazardous Goods Vehicles

The ATEX version of the tachograph is approved for use in hazardous goods vehicles. It differs from the standard tachograph as it has explosion protection and is certified in accordance with EU Directive 2014/34/EU.

#### Note!

The ATEX tachograph explosion protection is only guaranteed when the ignition is off and the battery isolating switch is open.

### The ATEX Tachograph

For the ATEX Tachograph some functions are disabled immediately when the ignition is switched off:

- Card trays cannot be ejected.
- Printouts are not possible.
- Background illumination for buttons and display is switched off.

#### Note!

The ATEX Tachograph will enter the power saving mode immediately after the ignition is switched off.

To have the ATEX Tachograph fully operational, the ignition key must be in position key-on or ignition on, depending on your vehicle manufacturer.

### Visible Differences

The ATEX tachograph will have additional information (ADR classification and TÜV test certificate number) printed on the label at the top of the tachograph.

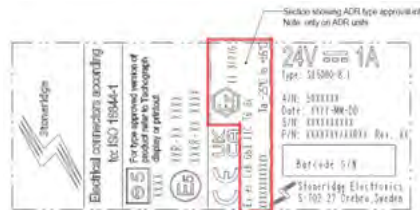

### Contact Stoneridge

Further information about Stoneridge SE5000-8.1 Smart Tachograph and

Stoneridge can be found at:  
[www.stoneridgeelectronics.com](http://www.stoneridgeelectronics.com)

# Index

## A

Activities .....	13, 17
Approval .....	90
ATEX	
ATEX tachograph version .....	93
Special features .....	93
Available .....	13, 17

## B

Begin country, see Places .....	16
Built-in Test .....	56
Buttons	
Arrow down .....	9
Arrow up .....	9
Back .....	9
Co-driver (2) .....	8
Driver (1) .....	8
OK (confirm) .....	9

## C

Calculations and Limits .....	89
-------------------------------	----

Card Trays (1= Driver, 2 = Co- driver) .....	8
Certification .....	90
Change	
Activity when stationary .....	13
Language .....	29
manual entry .....	19
Contact Stoneridge .....	1, 93
Control Manual .....	3

## D

DDS (Driver Decision Support) .....	29, 47, 89
Driver view, see Display .....	8
Driving .....	13-14

## I

Invert display .....	31
----------------------	----

## L

Language .....	29
----------------	----

## M

Manual entries .....	13, 17
Menus .....	13
Motions Sensor (Sensor) .....	9

## P

Paper .....	35
Power saving mode .....	35
Print menu .....	73
Printer .....	8

## R

Rest .....	13, 17
------------	--------

## S

Safety .....	1
Sensor .....	9
Set language .....	29
Settings .....	50
Company .....	45
Driver .....	29



---

**T**

- Tachograph ..... 8
- Trays (1= Driver, 2 = Co-driver) .... 8

**U**

- Unaccounted time ..... 17

**V**

- Vehicle Unit (Tachograph) ..... 8
- VRN (Vehicle Registration Number) 31

**W**

- Work ..... 13, 17
- Workshop Manual ..... 3
- WTD (Working Time Directive) .45, 50



Stoneridge Electronics AB

Adolfsbergsvägen 3  
702 27 Örebro, Sweden

[www.stoneridgeelectronics.com](http://www.stoneridgeelectronics.com)  
[www.se5000.com](http://www.se5000.com)

